

# Final Feasibility Study

January 2009

Proposed Railroad Grade Separation  
Algonquin Road and Union Pacific Railroad/Milwaukee Subdivision  
Mt. Prospect Road to Wolf Road  
City of Des Plaines

Prepared for:

City of Des Plaines  
Illinois Department of Transportation  
Union Pacific Railroad



City of Des Plaines  
Engineering Department  
1420 Miner Street  
Des Plaines, IL 60016  
Tel: 847-391-5390  
Fax: 847-391-5619



1051 Perimeter Drive, Suite 1025  
Schaumburg, Illinois 60173-5058  
T 847-605-9600  
F 847-605-9610  
[www.transystems.com](http://www.transystems.com)





TABLE OF CONTENTS

I. INTRODUCTION ..... 1  
    A. Background ..... 1  
    B. Purpose and Need ..... 1  
    C. Scope of Study ..... 1  
II. LOCATION AND EXISTING CONDITIONS ..... 2  
    A. Location ..... 2  
    B. Description of Existing Facilities ..... 2  
    C. Existing and Projected Traffic ..... 3  
    D. Crash History ..... 3  
    E. Drainage and Utilities ..... 4  
    F. Environmental Issues ..... 5  
III. ALTERNATE DESIGN STUDIES ..... 6  
    A. Alternate No. 1 ..... 6  
    B. Alternate No. 2 ..... 9  
    C. Alternate No. 3 ..... 11  
    D. No-Build Alternative ..... 12  
IV. TRAFFIC MANAGEMENT ..... 12  
V. CONSTRUCTABILITY ..... 13  
VI. COST ESTIMATES ..... 14  
VII. PROJECT COORDINATION ..... 14  
VIII. RECOMMENDED ALTERNATE ..... 15  
IX. FUNDING OPPORTUNITIES AND SCHEDULE ..... 16  
X. SUMMARY AND CONCLUSION ..... 17

## APPENDIX A – Exhibits

1. Project Vicinity Map
2. Typical Sections - Existing Algonquin Road
3. Project Area Aerial Map
4. Adjacent Land Use Map
5. Existing and Projected Average Daily Traffic Map
6. Crash Summaries
7. NWI Map
8. Flood Insurance Rate Maps
9. Typical Section – Alternate 1: Proposed Algonquin Road (Bridge Over UPRR)
10. Typical Section – Alternate 1: Proposed Algonquin Road (Retaining Wall)
11. Typical Section – Alternates 1 and 2: Proposed Algonquin Road (At-Grade)
12. Plan & Profile – Alternate No. 1
13. Typical Section – Alternate 2: Proposed Algonquin Road (UPRR Through-Girder Bridge)
14. Typical Section – Alternate 2: Proposed Algonquin Road (Roadway Under UPRR Bridge)
15. Typical Section – Alternate 2: Proposed Algonquin Road (Depressed Roadway)
16. Plan & Profile – Alternate No. 2
17. Alternative Comparison Matrix
18. Detour Map
19. Conceptual Estimate of Cost
20. Funding Opportunities

## APPENDIX B – Coordination

- Minutes of Meetings
- Utility Correspondence
- Agency and Property Owner Correspondence
  - i. ITW Fastex letter
  - ii. Chicago Metropolitan Agency for Planning
  - iii. IDNR EcoCAT
  - iv. US EPA CERCLIS locations
  - v. IEPA LUST locations
  - vi. PACE routes
  - vii. U.S. DOT Crossing Inventory Sheet



## APPENDIX C – Design Criteria

## APPENDIX D – Photographs

## APPENDIX E – Design Visualizations (Alternates 1 and 2)

- Design Visualization 1: Project overview looking south
- Design Visualization 2: Looking south from Park District
- Design Visualization 3: Looking west along Algonquin Road near Park District entrance
- Design Visualization 4: Looking east along Algonquin Road near structure
- Design Visualization 5: Looking south along UPRR – One / Three Span Bridge (Alternate 1 only)
- Design Visualization 6: Looking east from ITW (Alternate 1 only)
- Design Visualization 6: Looking east from UOP (Alternate 1 only)

THIS PAGE LEFT INTENTIONALLY BLANK

## I. INTRODUCTION

### A. Background

The City of Des Plaines has a total of 32 at-grade railroad crossings which impede vehicular traffic, including emergency vehicles, from moving through the city. A combination of increasing roadway and rail traffic in the future will only add to the travel delays caused by long and slow moving trains blocking the at-grade crossings. An internal study conducted by the City of Des Plaines in 2006 showed that the Algonquin Road crossing of the Union Pacific-Milwaukee Railroad (UPRR/Milwaukee) as the most feasible location for a grade separation. This finding was based on emergency response routes, vehicular and rail traffic volumes, FRA safety index, and other criteria. A Validation Study was performed by TranSystems (May 2008) which confirmed the City's finding.

### B. Purpose and Need

The primary purpose of the project is to provide a grade separation of rail-vehicle traffic to provide a through route for vehicles that is not impeded by rail traffic.

The need is based on reducing emergency response delays and mitigating the increased traffic delays in the City that are due to increasing train volumes.

### C. Scope of Study

The objective of this study is to evaluate feasible design alternates for the separation of Algonquin Road and the UPRR/Milwaukee. The design alternate analysis addresses conceptual roadway geometrics, right-of-way acquisition, impacts to adjacent properties, drainage, environmental impacts, staging, and construction costs.

The study was conducted in five steps. The first step was to identify and evaluate the existing conditions and establish the purpose and need for the project. The second step was to coordinate with the participating agencies to identify known problem areas and future needs. The third step involved the development and evaluation of alternates. The fourth step was to derive conclusions from the study and to make recommendations for additional studies, design and eventual implementation. The final step involved the review of funding possibilities and project implementation.

## II. LOCATION AND EXISTING CONDITIONS

### A. Location

The project is located in the City of Des Plaines in Cook County, Illinois. The project limits extend along Algonquin Road from east of Mt. Prospect Road to west of Wolf Road, a distance of approximately one-half mile. O'Hare International Airport is located approximately two miles south of the project and the Des Plaines River is approximately two miles east of the project. See Project Vicinity Map, Exhibit 1.

### B. Description of Existing Facilities

Existing Algonquin Road is a two-lane roadway within the project limits and is under the maintenance and jurisdiction of the Illinois Department of Transportation (IDOT). It is classified as a Minor Arterial (Urban) and has a federation aid designation of FAU 3515. Algonquin Road is not a truck route and there are no PACE routes within the project limits. The Algonquin Road right-of-way is 100 feet wide. Adjacent to the project limits, Algonquin Road consists of two lanes in each direction and a center turn lane at the two adjacent signalized intersections of Mt. Prospect Road and Wolf Road. Mt. Prospect Road is under the jurisdiction and maintenance of the Cook County Highway Department. Wolf Road is under the jurisdiction and maintenance of IDOT. Algonquin Road west of Mt. Prospect Road and east of Wolf Road is a two-lane roadway. See Exhibits 2A and 2B, Existing Algonquin Road Typical Sections.

Per preliminary staff discussions, IDOT will require a jurisdictional transfer of Algonquin Road to the City as part of this grade separation project. The proposed limits of the jurisdictional transfer would be Mt. Prospect Road to Wolf Road which would include the east leg of the Mt Prospect Road intersection and the west leg of the Wolf Road intersection. Algonquin Road, west of Mt. Prospect Road, is under the jurisdiction of IDOT. Algonquin Road, east of Wolf Road is under the jurisdiction of the City of Des Plaines. A project report will need to be submitted to IDOT for review and approval and discussed at the district FHWA coordination meetings. The agreement shall conform to the IDOT's participation policies for joint agreements as specified in Section 5-6.01 of the Bureau of Design and Environment Manual. The specific arrangements for the transfer will be negotiated and memorialized in the agreement.

The UPRR/Milwaukee crossing Algonquin Road is a double track main freight corridor. It runs between the western United States and northern Illinois and Wisconsin. The tracks are 14 feet on centers. The UPRR/Milwaukee right-of-way is 110 feet wide. Spur tracks are located both north and south of Algonquin Road before the crossings of Oakton and Dempster Streets. A wayside signal exists between Algonquin Road and Dempster Street. The railroad crossings at both Oakton Street and Dempster Street are at-grade and signalized. A UPRR service road exists north of Algonquin Road along the west side of the tracks. UPRR indicated that this service road is an abandoned third track line and that a service road this area is not needed.

Along Algonquin Road, the land use within the project is light industrial/commercial. A Des Plaines Park District facility, Mountain View Adventure Center, is located adjacent to the eastern right-of-way of



UPRR/Milwaukee, on the north side of Algonquin Road. There are large setbacks and few driveways, resulting in a good location for a grade separation. The area surrounding the project is also light industrial/manufacturing/warehouse with areas of residential uses. See Exhibit 3, Project Area Aerial Map and Exhibit 4, Adjacent Land Use Map. See Appendix D, Photographs.

#### C. Existing and Projected Traffic

The existing average daily traffic (ADT) along Algonquin Road is 11,100 vehicles. The existing ADT was obtained from the Illinois Department of Transportation Traffic Map. The Chicago Metropolitan Agency for Planning (CMAP) projected the Year 2030 traffic to be 12,000 vehicles. Correspondence with CMAP can be found in Appendix B. See Exhibit 5, Existing and Projected Average Daily Traffic Map.

Existing rail traffic consists of 47 freight trains per day within the project limits. The freight trains typically operate between 10 and 30 mph with a maximum speed of 50 mph. There are no commuter trains within the project limits. See Appendix B, U.S. DOT Crossing Inventory Information.

#### D. Crash History

Crash data along Algonquin Road from the three most recent years (2005 – 2007) were reviewed for the roadway segment between Mt. Prospect Road and Wolf Road. Data was provided by the City of Des Plaines. A total of 27 crashes were reported during the study period. The most common crash types were rear-end (66.7%), side swipe-same direction (11.1%) and fixed object (7.4%). The majority of crashes occurred during the day (81%) and during dry pavement conditions (78%). Thirteen of the crash reports specifically mentioned the UPRR/Milwaukee railroad crossing having an effect on the crash. Twelve were rear ended type crashes and one was a railroad signal strike. Crashes at the Algonquin Road intersections with Mt. Prospect Road and Wolf Road were not reviewed. See Exhibits 6A to 6C, Crash Summaries.

Based on the predominant crash types, Algonquin Road will benefit by the proposed improvements by the following:

- Grade separating Algonquin Road and the UPRR will minimize railroad induced crashes and reduce fixed-object collisions.
- Providing additional through lanes and eliminating lane drops will help reduce side swipe and rear-end crashes by increasing through capacity.
- Providing turn lanes will also help reduce rear-end and side swipe crashes by increasing turning and through traffic capacity, and providing a separate lane for left turning traffic.

**E. Drainage and Utilities**

Algonquin Road has curb and gutter near the Mt. Prospect Road and Wolf Road intersections which utilizes a 48 inch enclosed storm sewer system that carries stormwater east and outlets into the Des Plaines River. Between the intersections, Algonquin Road utilizes ditch drainage that flows east and outlets into the existing storm sewer system except for the Des Plaines Park District frontage. This area sheet flows outside the right-of-way into ponds within the Park District. The City and adjacent property owners are not aware of any existing drainage problems within the project limits.

The UPRR utilizes ditch drainage that flows south. There are no culverts crossing under Algonquin Road along the UPRR ditch line. The northwest corner of Algonquin Road and UPRR drains into an end section which connects into the 48 inch storm sewer along Algonquin Road. The northeast corner of Algonquin Road and UPRR drains into the Des Plaines Park District ponds.

The following is a summary of the existing utilities within the project limits.

<u>Owner</u>	<u>Type</u>	<u>Location</u>
City of Des Plaines	Storm sewer, 48"	South side of Algonquin Road
City of Des Plaines	Culvert, 48"	Crossing Algonquin Road
City of Des Plaines	Water main, 10"	North side of Algonquin Road
City of Des Plaines	Water main	West side of UPRR/Milwaukee
City of Des Plaines	Sanitary sewer, 18"	North side of Algonquin Road
Commonwealth Edison	Overhead lines	South side of Algonquin Road
Commonwealth Edison	Overhead lines	East side of UPRR
UPRR	Overhead lines	West side of UPRR
Level 3 Communication	Underground	West side of UPRR/Milwaukee
Comcast	Underground	North side of Algonquin Road
Nicor	Gas main	North side of Algonquin Road
AT&T/Local	Underground/Aerial	South side of Algonquin Road
MWRD	Not involved	Not applicable
AT&T/Long Distance	Not involved	Not applicable
MCI	Not involved	Not applicable
XO Illinois	Not involved	Not applicable

A listing of utility companies has been obtained from JULIE. Individual utility companies were contacted to obtain existing and proposed facility information within the project limits. See Appendix B for correspondence with the utility companies.

**F. Environmental Issues**

A preliminary review of environmental resources was conducted for the project using on-line databases from resource agencies. A complete review will need to be performed during the preliminary engineering phase of the project. Below is a summary of the resources within the project limits. See Exhibit 7, NWI Map and Exhibit 8, Flood Insurance Rate Maps. See Appendix B for database results for threatened and endangered species, Leaking Underground Storage Tank (LUST) sites and Comprehensive Environmental Response, Compensation, and Liability Information System (CERCLIS) sites.

<u>Resource</u>	<u>Present</u>	<u>Not Present</u>	<u>Unknown</u>	<u>Source</u>
Wetlands	<input checked="" type="checkbox"/>	<input type="checkbox"/>	<input type="checkbox"/>	NWI Database
Floodplain	<input type="checkbox"/>	<input checked="" type="checkbox"/>	<input type="checkbox"/>	FIRM Maps
Archeological/Historic	<input type="checkbox"/>	<input checked="" type="checkbox"/>	<input type="checkbox"/>	Field review
Threatened or Endangered Species	<input type="checkbox"/>	<input checked="" type="checkbox"/>	<input type="checkbox"/>	IDNR/EcoCat
Wild or Scenic Rivers	<input type="checkbox"/>	<input checked="" type="checkbox"/>	<input type="checkbox"/>	Field review
Section 4(f) Lands	<input checked="" type="checkbox"/>	<input type="checkbox"/>	<input type="checkbox"/>	Des Plaines Park District
Special/Hazardous Waste	<input type="checkbox"/>	<input type="checkbox"/>	<input checked="" type="checkbox"/>	Note 1
LUST Site (1,000 feet)	<input checked="" type="checkbox"/>	<input type="checkbox"/>	<input type="checkbox"/>	IEPA
CERCLIS Site (1 mile)	<input checked="" type="checkbox"/>	<input type="checkbox"/>	<input type="checkbox"/>	EPA
Air and Noise	<input type="checkbox"/>	<input type="checkbox"/>	<input checked="" type="checkbox"/>	Note 2

Note 1 – Preliminary Environmental Site Assessment (PESA) and Preliminary Site Investigation (PSI) are required during preliminary engineering studies for the preferred alternate.

Note 2 –Air and noise impact analysis are required during preliminary engineering studies for the preferred alternate.

### III. ALTERNATE DESIGN STUDIES

The study of the proposed grade separation of Algonquin Road and UPRR/Milwaukee resulted in three proposed alternates and an analysis of the No-Build alternate. Based on the projected traffic growth in the project vicinity and adjacent sections, the proposed Algonquin Road typical section for all alternates consists of two 12-foot traffic lanes in each direction, a striped median, curb and gutter on each side, sidewalk along the south side and a ten-foot off-street shared-use path along the north side. Both the sidewalk and shared path will be extended to the Mt. Prospect and Wolf Road intersections. The proposed shared path will connect to the Park District shared path network at Mountain View Adventure Center. Existing Algonquin Road will be widened to a five-lane section for all alternates between the existing five-lane sections at the Mt. Prospect and Wolf Road intersections and where the proposed profile improvements end. These existing intersections are not anticipated to be impacted by the project. Consideration should be made to evaluate the intersections during preliminary engineering studies since the project limits extend within the influence of the intersections, are logical project termini and will be part of the jurisdictional transfer.

The alternates were designed to meet Illinois Department of Transportation criteria. Since the roadway will be under local jurisdiction, design criteria for roadway elements were based on an arterial design from the Bureau of Local Roads and Streets Manual. The design speed was set at 40 mph and is 5 mph above the existing posted speed limit. All alternates have to be constructed in a way that maintains rail traffic throughout the construction period. Design criteria for all proposed rail work were taken from UPRR Standards or current UPRR projects. See Appendix C, Design Criteria.

#### A. Alternate No. 1

This design alternate separates the roadway and railroad by raising Algonquin Road over the UPRR/Milwaukee. The UPRR/Milwaukee will remain at its existing elevation. The existing horizontal alignment of Algonquin Road does not change. The roadway profile is to be raised so the low beam elevation of the Algonquin Road bridge will be 29-feet, 6-inches above the top of existing rail elevation. The maximum longitudinal roadway slope is five percent to meet Americans with Disabilities Act (ADA) guidelines for sidewalk longitudinal slopes.

The bridge over UPRR/Milwaukee is estimated to be one span and 120 feet long. The abutments are set to be outside the UPRR/Milwaukee right-of-way so they will not be impacted by any future improvements by the UPRR/Milwaukee. The bridge was assumed to have 72-inch PPC bulb T-beams as a result of a conceptual comparison of PPC beams and steel girders. 72-inch PPC bulb T-beams are the largest standard size manufactured. PPC beams have a lower initial cost than steel girders, do not require painting, and have a faster fabrication time. However, the structure depths for PPC beams, per the span length required, will be approximately two feet deeper than steel girders. This additional depth will increase quantities for retaining wall, embankment and add to the height of the structure. For the purposes of this report, the PPC structure depth was carried forward to ensure the impacts caused by the higher profile did not rule out the use of PPC bulb T-beams during the preliminary engineering phase.

A three span bridge having 90'-120'-90' segments was also considered to provide a larger opening at the railroad, to reduce the area of visible retaining wall, especially at the Park District, and to provide additional sight lines. The cost for either bridge option is similar when the additional embankment, retaining wall and pavement are added to the single span bridge. The single span was chosen because future maintenance will be less for the single span option. The bridge type and size will be explored further and finalized during preliminary engineering studies. Design visualizations for both bridge types are included in Appendix E.

Two options were evaluated for the roadway fill section. Alternate 1A utilizes retaining walls to confine the roadway section within existing right-of-way. The retaining walls would have an approximate maximum height of 30 feet and would taper down to existing ground to a point where the proposed profile matches existing. Alternate 1B uses 3:1 side slopes to match into existing ground elevation or to locations where reduced height retaining walls are utilized. Ditches will be required at the bottom of the side slopes to collect roadway stormwater. Right-of-way acquisition is necessary to accommodate the 3:1 side slopes and ditches. Sections of full height retaining wall will still be required for the Park District frontage and entrance, as well as in the southwest corner of the bridge to avoid the wetland. Reduced height retaining walls will be required along the UOP frontage entrance and Juno Lighting parking lot to keep the embankment from impacting the existing parking lot and to provide a space for parking space mitigation.

The bridge typical section includes two 12-foot thru lanes in each direction, a 12-foot flush median, curb and gutter, a ten-foot shared path on the north side and a six-foot sidewalk on the south side. The fill typical section matches the bridge typical section. At the limits of the fill section, the 12-foot flush median is developed into center turn bays and bidirectional turn lanes. In the at-grade section, the 12-foot bidirectional turn lane will widen to a 16-foot flush median to match the existing five-lane cross section at the Mt. Prospect and Wolf Road intersections. See Exhibits 9, 10 and 11, Proposed Typical Sections-Alternate No. 1.

Property impacts include three driveway relocations, one driveway consolidation and the reconstruction of over 400 feet of Des Plaines Park District's entrance. Specific impacts for adjacent property owners are discussed below. A Plan and Profile exhibit has been prepared to present the proposed geometrics and to evaluate the adjacent property impacts. See Exhibit 12, Plan and Profile-Alternate 1 and Exhibit 17, Alternative Comparison Matrix to review the summary of impacts.

#### UOP/Honeywell

The UOP driveway at 200 E. Algonquin Road is proposed to be relocated approximately 500 feet west via a frontage road due to the profile raise for both Alternate 1A and 1B. The driveway is located within 60 feet of the proposed bridge and will not be able to meet grade requirements without impacting the existing parking lot and building. UOP has three other driveways for access. If approved by UOP, this driveway can be closed. Approximately nine parking spaces will need to be mitigated as a result of the driveway relocation. Temporary easements are shown for other driveway locations for possible driveway grading requirements.

Alternate 1B would require proposed right-of-way and temporary easements along the north side of Algonquin to accommodate the embankment footprint and reduced height retaining walls. The driveway is designed for a SU vehicle.

#### Des Plaines Park District

The Park District's entrance will be raised 15 feet at Algonquin Road and will need to be reconstructed on retaining wall for both Alternate 1A and 1B to avoid impacting the ponds on the east and west sides of the entrance. The reconstruction limits were determined by assuming 100 feet of storage at Algonquin Road at a two percent slope and then matching back into the existing elevation at a five percent slope. Over 500 feet of shared path will need to be reconstructed around the pond to the east of the Park District entrance. The raising of Algonquin Road will require the raising of portions of the shared path to meet ADA requirements. Additionally, the construction of retaining wall for the entrance will create impacts to the adjacent section of the shared path. Because of these impacts to the Park District, a Programmatic Section 4(f) Document will need to be prepared due to the potential change in character of the facility resulting from the surrounding retaining walls. A maintenance agreement will need to be developed with the Park District for the entrance retaining walls which may require the establishment of a permanent easement. The entrance is designed for a SU vehicle.

#### ITW Fastex

The ITW Fastex driveway will require relocation due to the Algonquin Road profile raise for Alternate 1A. Its current position is 250 feet from the proposed bridge. The driveway is proposed to be relocated to the western edge of the property and then to extend and connect to the existing parking lot approximately 300 feet south of Algonquin Road. At its relocated position, the Algonquin Road profile raise has less influence on the driveway's grade. The portion of the driveway that is parallel to Algonquin Road is located as close to the building as practical, as requested by the owner, to maximize space for future expansion. The proposed driveway could be replaced at or near its current location for Alternate 1B and match into the existing parking lot. Alternate 1B would require proposed right-of-way along the south side of Algonquin to accommodate the embankment footprint. The driveway is designed for a WB-65 truck.

#### Juno Lighting

The Juno Lighting driveway along Algonquin Road will require relocation due to the Algonquin Road profile raise for both Alternate 1A and 1B. The driveway is located 400 feet from the proposed bridge. The driveway is proposed to be relocated to the eastern edge of the existing parking lot where a six percent driveway slope can be attained. Approximately 30 parking spaces will need to be mitigated as a result of the driveway relocation. There is adequate space to mitigate these parking spaces on site. The driveway is designed for a WB-65 truck. Alternate 1B would require proposed right-of-way along the south side of Algonquin to accommodate the embankment footprint in the area where retaining walls are eliminated or minimized.

### Commercial Area

The two driveways for the strip mall at 526-537 E. Algonquin Road will require consolidation to meet driveway slope criteria. The western driveway will not be able to meet the slope criteria for commercial driveways. The eastern driveway will be widened and parking lot rehabilitated to grade the driveway. Minor grading may be required at Star Automotive, 540 E. Algonquin Road, as a result of the profile raise and adjacent parking lot grading.

### UPRR/Milwaukee

This alternate has the least degree of impact to UPRR/Milwaukee. The railroad will only have minor inconveniences as a result of the adjacent construction to Algonquin Road.

A third option for Alternate 1 is to lower the UPRR two feet or less. Lowering the railroad would reduce earthwork and retaining wall costs; however, a shoofly would be necessary and there would be an associated cost for its construction.

## **B. Alternate No. 2**

This design alternate separates the roadway and railroad by depressing Algonquin Road under the UPRR/Milwaukee. The UPRR/Milwaukee will remain at its existing elevation. The existing horizontal alignment of Algonquin Road does not change. The roadway profile is to be lowered so the low beam elevation of the UPRR/Milwaukee bridge will be 14-feet, 9-inches above the proposed profile grade line of Algonquin Road. The low point of the roadway profile is placed 100 feet away from the face of the bridge so it is not in the shadow of the bridge. The maximum longitudinal roadway slope is five percent to meet ADA guidelines for sidewalk longitudinal slopes. The UPRR/Milwaukee bridge is assumed to be a steel deck girder that is ten feet deep from top of rail to bottom of beam. A steel thru-plate girder will have a four-foot shallower structure depth, but the UPRR preference is a deck girder. The bridge is estimated to be one span and 86 feet long. The bridge will accommodate the two existing tracks at their existing offset.

Two options were evaluated for the roadway cut section. Alternate 2A utilizes retaining walls to confine the roadway section within existing right-of-way. The retaining walls would have an approximate maximum height of 21 feet and would taper down to existing ground to a point where the proposed profile matches existing. Alternate 2B uses 2:1 side slopes to match into existing ground elevation. Sections of retaining walls will still be required for UOP, the Park District frontage and entrance, as well as in the southwest and southeast corners of the bridge to minimize wetland impacts.

The typical section of this alternate for Algonquin Road under the bridge includes two 12-foot thru lanes in each direction, a 12-foot flush median, curb and gutter, a ten-foot shared path on the north side and a six-foot sidewalk on the south side. A two-foot buffer will separate the sidewalk and abutment/retaining wall. The retaining wall section would match the bridge section. A chain link fence or other barrier will need to be provided on top of the retaining wall. In the at-grade section, the 12-foot bidirectional turn lane will widen to

a 16-foot flush median to match the existing five-lane cross section at the Mt. Prospect and Wolf Road intersections. See Exhibits 11, 13, 14 and 15 Proposed Typical Sections-Alternate 2,

This alternate result in a similar profile match-in point to Alternate 1 and has the least impacts to adjacent properties. Two driveway relocations are required. Because the roadway profile is lowered below the existing storm sewer system, a pump station will need to be provided. The proposed retaining wall will be bumped out to accommodate the pump station at the roadway elevation to permit access. The bump out will be large enough to accommodate the pump building, electrical panel and a parking area that will allow vehicles to turn around and allow forward egress. A Plan and Profile exhibit has been prepared to present the proposed geometrics and to evaluate the adjacent property impacts. See Exhibit 16, Plan and Profile-Alternate 2 and Exhibit 17, Alternative Comparison Matrix to review the summary of impacts.

#### UOP/Honeywell

The UOP driveway at 200 E. Algonquin Road is proposed to be relocated approximately 500 feet west via a frontage road due profile for both Alternate 2A and 2B. The driveway is located within 60 feet of the proposed bridge and will not be able to meet grade requirements without impacting the existing parking lot and building. UOP has three other driveways for access. If approved by UOP, this driveway can be closed. Temporary easements are shown for other driveway locations for possible driveway grading. Alternate 2B would require proposed right-of-way and temporary easements along the north side of Algonquin to accommodate the excavation footprint and reduced height retaining walls. Right-of-way will be required for both Alternate 2A and 2B. The pump station is proposed to be located on UOP property because the three other quadrants that abut the UPRR/Milwaukee contain Section 4(f) lands or wetlands. The driveway is designed for a SU vehicle.

#### ITW Fastex

The ITW Fastex driveway will require relocation due to the Algonquin Road profile raise for Alternate 2A. The driveway is currently located 250 feet from the proposed bridge. The driveway is proposed to be relocated to the western edge of the property where lowering the profile has less influence and connects with the existing parking lot 300 feet south of Algonquin Road. The portion of the driveway that is parallel to Algonquin Road is located as close to the building as practical, as requested by the owner, to maximize space for future expansion. The proposed driveway could be replaced at or near its current location for Alternate 2B and match into the existing parking lot. Alternate 2B would require proposed right-of-way along the south side of Algonquin to accommodate the excavation footprint. The driveway is designed for a WB-65 truck.

#### Juno Lighting

Alternate 2B would require proposed right-of-way along the south side of Algonquin to accommodate the excavation footprint in the area where retaining walls are eliminated.



### UPRR/Milwaukee

This alternate impacts UPRR/Milwaukee more than Alternate 1 because a shoofly is required to be constructed around the proposed bridge construction to maintain rail service. The shoofly is proposed to be located along the west side of the existing tracks. This side was chosen because it has more width within the existing right-of-way and will not bring rail traffic closer the Park District facility. Temporary easements will be required along the west right-of-way to allow for grading of the shoofly. The shoofly is placed at a minimum of 31 feet on centers from the outer most rail. Temporary sheet piling will be required south of Algonquin Road to minimize impacts to the wetland and an existing bungalow will need to be removed and replaced until the construction of the underpass is complete. It is anticipated that the UPRR will have maintenance responsibilities from the waterproofing membrane and above. The City will have maintenance below the waterproofing membrane, which includes the substructure and superstructure. A railroad agreement will be required.

A third option for this alternate is to raise the UPRR two feet or less to reduce earthwork and retaining wall costs. The UPRR can perform this amount of track raise using maintenance procedures which will not significantly impact their operations.

### C. Alternate No. 3

This design alternate separates the roadway and rail by a combination of depressing Algonquin Road under the UPRR/Milwaukee tracks and raising UPRR/Milwaukee. This will allow pavement drainage along Algonquin Road without a pump station. The existing horizontal alignment of Algonquin Road does not change. The roadway profile is to be lowered so the low beam elevation of the UPRR/Milwaukee bridge will be 14-feet 9-inches above the proposed profile grade line of Algonquin Road. The low point of the roadway profile is placed 100 feet away from the face of the bridge so it is not in the shadow of the bridge. To eliminate a conflict with the 48 inch storm sewer, it is required to raise the UPRR/Milwaukee a minimum of 12 feet. However, to avoid impacting Dempster and Oakton Street, UPRR/Milwaukee at a maximum can only be raised approximately nine feet. Because of this, the 48inch storm sewer will need to be replaced with multiple smaller pipes near the roadway low point. The longitudinal roadway slope is set at one percent. The UPRR/Milwaukee bridge is assumed to be the same as Alternate 2. The roadway will be supported by retaining walls within the cut sections. The typical section of this alternate for Algonquin Road under the bridge is assumed to be the same as Alternate 2.

The maximum grade along UPRR is proposed at 0.65 percent. The match points would need to be before the crossing at Oakton Street and the spur location south of Dempster Street. The UPRR mainline tracks would need a split shoofly both to the east and west of the existing track in order to construct the new tracks and avoid impacts to adjacent residential and commercial properties. Retaining walls would be required to keep the improvement within the existing right-of-way. Temporary easements are required along both west and east sides of the right-of-way for construction of the shoofly.

This alternate results in the longest profile match-in, and similar impacts to adjacent properties as Alternate 2. One driveway closing and one driveway relocation is required. This alternate impacts the UPRR/Milwaukee the most because a nine foot track raise is required. The UPRR can raise track elevations up to two feet using maintenance procedures which will not significantly impact their operations. Any adjustment over two feet requires mainline reconstruction. Consequently, a longer shoofly will be required to be constructed around both the proposed bridge construction and the proposed mainline reconstruction.

Alternate 3 will require extensive UPRR coordination and major construction of both the UPRR, Algonquin Road, and both the north and south spur tracks. Alternate 3 is also over 50 percent more expensive than Alternates 1 and 2. As a result of these reasons Alternate 3 is removed from further consideration.

#### D. No-Build Alternative

The No-Build alternate does not meet the purpose and need of the project. Given the proposed increase in rail and vehicular traffic, delays will continue to worsen. As a result of these reasons, the No-Build Alternate is removed from further consideration.

### IV. TRAFFIC MANAGEMENT

#### Algonquin Road

For both Alternates 1 and 2, the preferred method of constructing Algonquin Road is to close the roadway to through traffic and allow local traffic access. The full closure will reduce the total duration of construction and reduce project costs. Local access will not be allowed to cross the railroad. Driveways will need to be relocated prior to grading operations to allow the local access. For Alternate 1, the Park District entrance will require approximately one month full closure for construction of the retaining wall and embankment. The project should be let and phased so this entrance can be open between April 1 and October 31.

#### UPRR

Alternate 1 will require coordination with UPRR during the setting of beams over their tracks. The beams will be set during off-peak times as determined by the UPRR. Alternate 2 will require railroad force work to construct the shoofly in order to maintain rail traffic throughout the bridge construction. Rail traffic will be affected for a few hours when the shoofly is connected to the mainline tracks. Construction of Algonquin Road will be dependent on UPRR completion which may increase the time frame of the Algonquin Road closure.

This project should not require multi-year stage construction and should be able to be substantially constructed as one project in one construction season. Certain plantings and miscellaneous punch list items may carry the project to the Spring following substantial completion.

## V. CONSTRUCTABILITY

### Algonquin Road

Construction operations for Alternate 1 will consist of relocating driveways, utility relocation and construction of the embankment, retaining walls and bridge. Geotechnical investigations will be performed during Phase I engineering which will help determine retaining wall types and locations of unstable soils that require replacement. Due to the height of embankment for Alternate 1, existing underground utilities such as the sanitary sewer, water main and storm sewer are assumed to require replacement. These existing utilities may not have the strength to withstand the additional dead load. Additionally, the increased depth below ground line may preclude future maintenance to these facilities.

Construction operations for Alternate 2 will consist of relocating driveways and utilities, installation of temporary retaining wall between the shoofly and mainline track and in front of the wetland, construction of the shoofly, excavation, construction of the UPRR bridge, removal and replacement of the signal equipment bungalow, reinstallation of the mainline tracks, removal of the shoofly, construction of the retaining walls and construction of the pump station. Geotechnical investigations will be performed during Phase I engineering which will help determine retaining wall types, excavation procedures, locations of unstable soils that require replacement and ground water conveyance to the underpass. Alternate 2 has the potential to be more complicated than Alternate 1 because subterranean construction is inherently more uncertain and more dependent on existing soil types and conditions. The proximity of open water bodies to the depressed roadway poses potential future maintenance problems and possibly more complicated construction methods.

### UPRR/Milwaukee

Alternate 1 is not anticipated to require railroad force work except for flaggers for the construction of the bridge over UPRR. Alternate 2 will require railroad force work to construct and remove the shoofly, remove and relocate signal bungalow, install temporary shoring for the bridge construction and the removal and replacement of mainline track over the newly constructed bridge.



**VI. COST ESTIMATES**

Conceptual cost estimates have been prepared for each alternate based on major work items. The total construction costs are provided below and include construction, right-of-way, engineering and contingencies. See Exhibit 20, Conceptual Cost Estimates.

Alternate 1A (Algonquin Road Over UPRR) .....	\$27,434,520
Alternate 1B (Algonquin Road Over UPRR) .....	\$27,316,620
Alternate 2A (Algonquin Road Under UPRR) .....	\$29,786,750
Alternate 2B (Algonquin Road Under UPRR) .....	\$28,941,550
Alternate 3 (Algonquin Road Under UPRR with Track Raise) .....	\$48,201,290

**VII. PROJECT COORDINATION**

Close coordination of the project with the City, UPRR, IDOT, ICC, businesses, and impacted agencies was performed. This coordination effort will minimize unforeseen delays or unexpected impacts during the design and construction phases of the project. The UPRR has expressed their preference to be Alternate 1 and will not support Alternate 2. The ICC has remained neutral and wishes to be involved only when a preferred alternate is chosen.

At this time no formal public hearing or open house is recommended due to the preliminary nature of the feasibility study. However, coordination with the adjacent property owners has been conducted. In addition to presentations to the City engineering staff, additional presentations could be made to individual Aldermen or the City Council. Below is a listing of agencies with which the project has been coordinated as part of the study.

- City of Des Plaines
- Illinois Department of Transportation
- Union Pacific Railroad
- Federal Highway Administration
- Illinois Commerce Commission
- Des Plaines Park District
- Adjacent Businesses
- Chicago Metropolitan Agency for Planning
- Northwest Municipal Conference
- Illinois Department of Economic Development
- Illinois Environmental Protection Agency
- Illinois Department of Natural Resources
- State Historic Preservation Office
- Private Utility Companies

## VIII. RECOMMENDED ALTERNATE

Four alternates were evaluated based on geometrics, traffic, constructability, impacts to adjacent properties and project costs. Of these alternates studied, both Alternates 1A and 1B – Algonquin Road Over UPRR and Alternates 2A and 2B – Algonquin Road Under UPRR are considered to be feasible and reasonable alternates to carry forward. Alternate 1 provides the easiest path to construction by minimizing the involvement with the UPRR and by being the preferred alternate by UPRR. Alternate 1 has the simpler constructability and is not dependent upon railroad work. Alternate 2 is better for land-use as it does not block any sight lines.

Utility impacts are comparable for Alternates 1 and 2 unless it is determined that the 48 inch storm sewer and 18 inch sanitary sewer are not needed to be replaced for Alternate 1. The proposed gravity stormwater system for Alternate 1 will have less future maintenance needs than the pump station required for Alternate 2. In addition, having the roadway over the railroad will not subject Algonquin Road to the potential of flooding and road closures that could happen with Alternate 2. Alternate 1 has slightly more adjacent property impacts, including a Section 4(f) property involvement, but Alternate 2 will involve more wetland impacts. The profile raise for Alternate 1 may cause an increase in noise for adjacent property owners, but these are not sensitive receptors and the impacts are not expected to be significant enough to warrant noise mitigation. An underpass is visually less obtrusive than an overpass. In this location the adjacent land use is commercial/industrial so the height is less of an issue if it were adjacent to residential uses, however future planning should be taken into consideration. For either option, landscaping can be used to soften the appearance of the retaining wall or side slopes.

The determination of option A or B will depend on the cooperation of adjacent property owners. Typically, projects that minimize the amount of right-of-way acquisition, the number of parcels and parking loss/impacts have an easier path to construction. These adjacent property owners will need to become even more involved during the next phase of the project.

Ultimately, the decision to choose between Alternate 1 and 2 should be made in accordance with the City's long-term planning goals and with the involvement of stakeholders during the preliminary engineering.

## IX. FUNDING OPPORTUNITIES AND SCHEDULE

The grade separation of Algonquin Road and UPRR/Milwaukee is a feasible design to reduce delays and improve safety within the City of Des Plaines. All agencies involved in this study would benefit from the completion of this project. In addition to funding contribution from each agency, additional financing for this project may be acquired through the following programs. See Exhibit 20, Funding Opportunities.

- Congestion Mitigation and Air Quality Improvement Program (CMAQ)
- Grade Crossing Protection Fund (GCPF)
- Illinois Transportation Enhancement Program (ITEP)
- Surface Transportation Program (STP)
- SAFETEA-LU Federal Reauthorization Earmark
- Highway Safety Improvement Program (HSIP)
- Motor Fuel Tax (MFT)
- Municipal Improvement Program (CIP)
- Union Pacific Railroad CIP
- Jurisdictional Transfer. If the project is using supplemental funding, i.e. STP, CMAQ, ITEP, ICC, or Railroad, IDOT will typically pick up the unfunded costs. This can include Phase I and 2 engineering, construction and construction engineering. If supplemental funds are not being applied, IDOT could agree to fund almost everything, however this is dependent on the State's financial situation. An upper limit may be developed based on lane miles transferred and may not provide enough funds to complete the project. In addition, IDOT may limit the cost participation to at-grade roadway components and not the cost to grade separate.

Project funding and schedule are interrelated. For federally funded projects, no reimbursement of federal dollars will be allowed for expenditures made prior to the date of federal authorization. Therefore, unless the City wishes to use their own monies, approved funding will need to be acquired prior to the initiation of Phase I engineering. Specific programs that fund preliminary engineering, as listed in Exhibit 20, should be initially targeted. Many of the programs have set dates for application submittals which can leave the project on hold until the selections are made. Typically, the more the project is ready for construction, the better probability the project has to obtain funding. The City could initiate preliminary engineering at their own cost to try to position the project for potential funding as it becomes available. A funding strategy should be developed which could include an initial meeting with IDOT to discuss the terms of the jurisdictional transfer and the preparation of applications.



A general project schedule is provided below. The schedule is dependent on many factors such as funding, public involvement, environmental clearances and agency cooperation.

Funding Applications and Selection	1 year
Phase I Engineering	1 ½ years
Phase II Engineering and ROW	2 years
Letting and Construction	<u>1 ½ years</u>
Total	6 years

#### X. SUMMARY AND CONCLUSION

It is recommended that the preferred design alternatives presented in this study be further developed. The project should be pursued as a joint effort with the involvement of City of Des Plaines, IDOT, UPRR, and various other related agencies. The implementation of this project will improve traffic and safety needs along Algonquin Road as well as the regional roadway and railroad system.





APPENDIX A

EXHIBITS

## APPENDIX A

### EXHIBITS

1. Project Vicinity Map
2. Typical Sections - Existing Algonquin Road
3. Project Area Aerial Map
4. Adjacent Land Use Map
5. Existing and Projected Average Daily Traffic Map
6. Accident Summaries
7. NWI Map
8. Flood Insurance Rate Maps
9. Typical Section – Alternate 1: Proposed Algonquin Road (Bridge Over UPRR)
10. Typical Section – Alternate 1: Proposed Algonquin Road (Retaining Wall)
11. Typical Section – Alternates 1 and 2: Proposed Algonquin Road (At-Grade)
12. Plan & Profile – Alternate No. 1
13. Typical Section – Alternate 2: Proposed Algonquin Road (UPRR Through-Girder Bridge)
14. Typical Section – Alternate 2: Proposed Algonquin Road (Roadway Under UPRR Bridge)
15. Typical Section – Alternate 2: Proposed Algonquin Road (Depressed Roadway)
16. Plan & Profile – Alternate No. 2
17. Alternative Comparison Matrix
18. Detour Map
19. Conceptual Estimate of Cost
20. Funding Opportunities

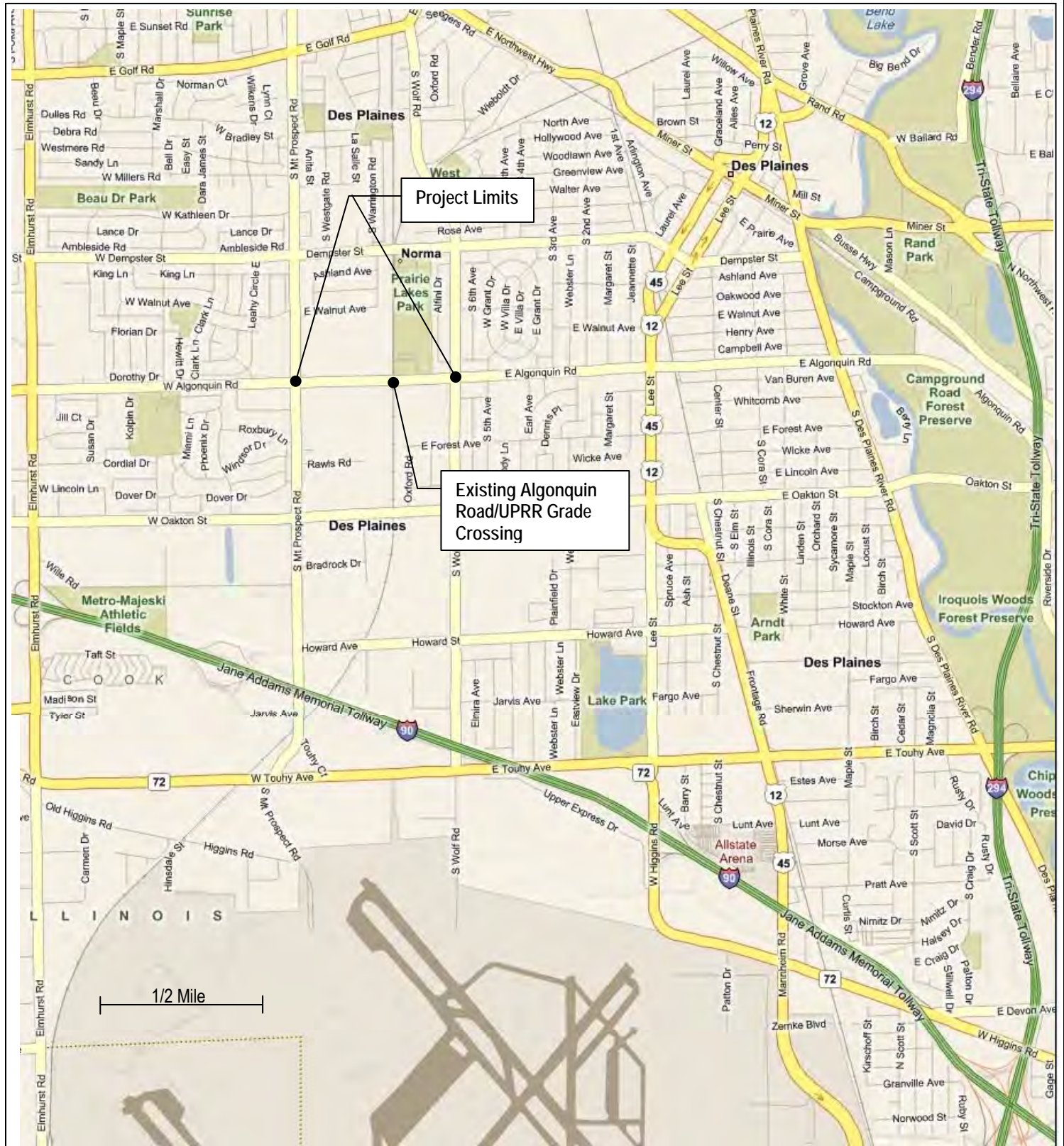

EXHIBIT 1



Maine Township  
T41 N, R12E; Section 19

**PROJECT VICINITY MAP**

Algonquin Road Grade Separation  
at the UPRR Milwaukee Subdivision  
Mount Prospect Road to Wolf Road  
City of Des Plaines



1051 Perimeter Drive, Suite 1025  
Schaumburg, Illinois 60173  
(847) 605-9600 | (847) 605-9610 Fax  
www.transystems.com

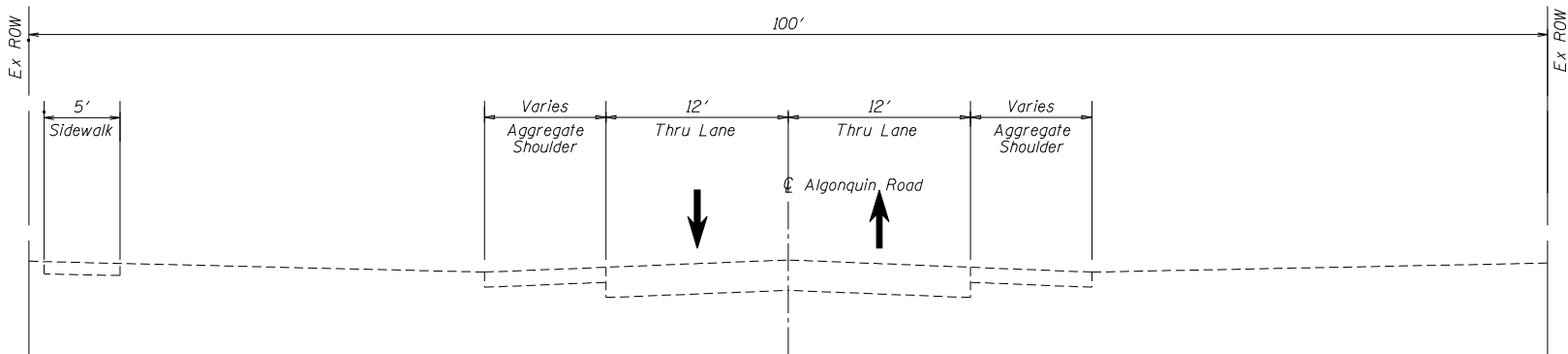

**EXHIBIT 2A**

**EXISTING TYPICAL SECTION**

*Algonquin Road  
Between Mt Prospect Road and Wolf Road*

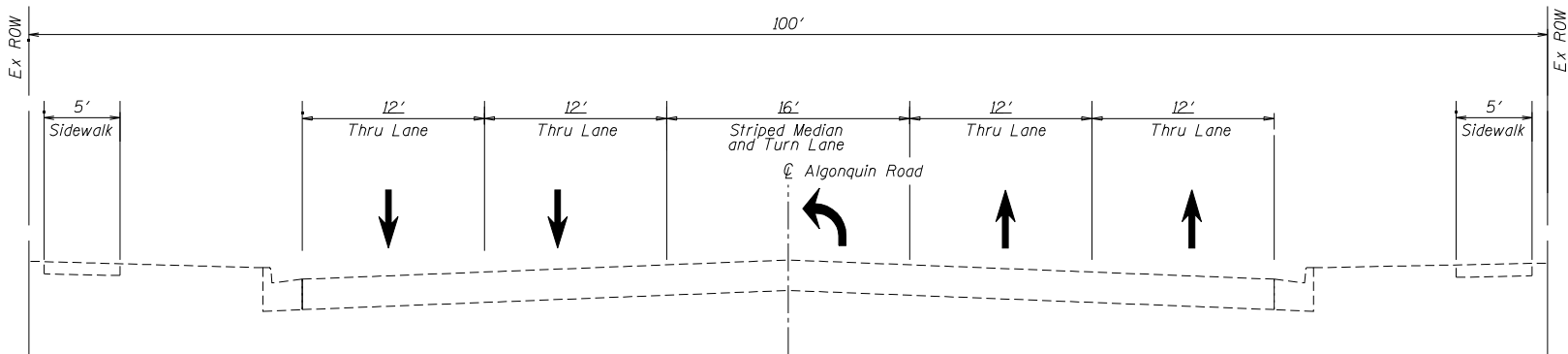

**EXHIBIT 2B**

**EXISTING TYPICAL SECTION**

*Algonquin Road  
At Mt Prospect Road and Wolf Road Intersections*

**PROJECT LIMITS**



0 100 200 300  
SCALE FEET



**TransSystems**

1084 PERIMETER DRIVE  
SUITE 1026  
SCHMIDT, ILL. 60178  
PHONE: 847-505-8000  
FAX: 847-505-9610



**DES PLAINES ILLINOIS**  
City of Des Plaines  
Engineering Department  
Des Plaines, IL 60016  
Tel.: 847-381-1380  
Fac.: 847-381-5819

**FEASIBILITY STUDY**  
PROPOSED RAILROAD GRADE SEPARATION  
ALCONQUIN ROAD AT UPRR/MILWAUKEE  
MT. PROSPECT ROAD TO WOLF ROAD  
CITY OF DES PLAINES

REVISIONS:	DATE	DESCRIPTION

PROJECT NO:	P401070151
SCALE:	1" = 100'
DATE:	10/10/2008
DESIGNED BY:	BAR
DRAWN BY:	MLB
CHECKED BY:	KKY

SHEET TITLE:  
**PROJECT AREA  
AERIAL MAP**

SHEET NO.  
**EXHIBIT 3**

Legend

-  Commercial/Industrial
-  Residential
-  Park / Open Space

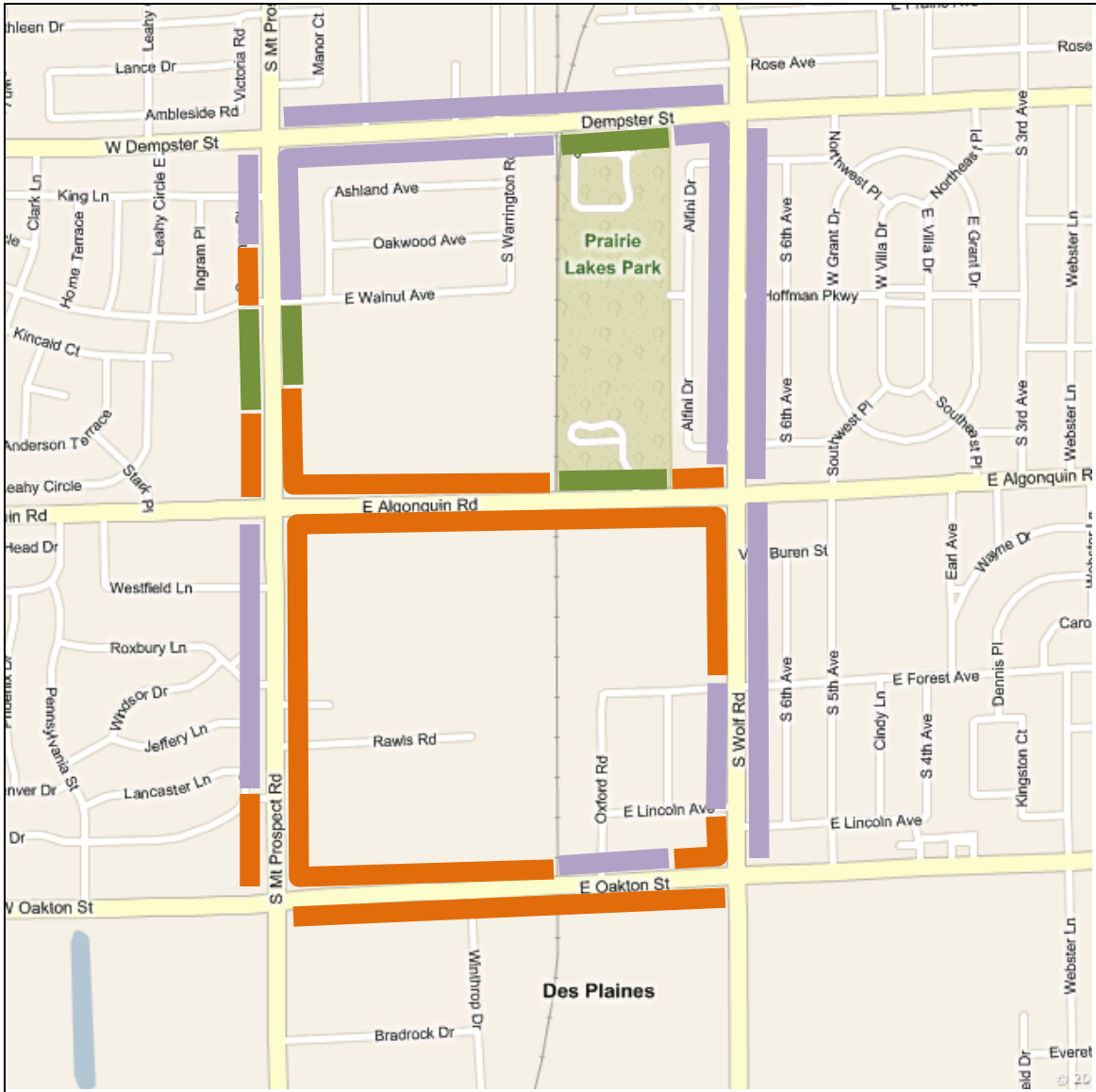
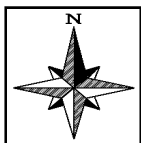

EXHIBIT 4



ADJACENT LAND USE MAP

Algonquin Road Grade Separation  
at the UPRR Milwaukee Subdivision  
Mount Prospect Road to Wolf Road  
City of Des Plaines



1051 Perimeter Drive, Suite 1025  
Schaumburg, Illinois 60173  
(847) 605-9600 | (847) 605-9610 Fax  
www.transystems.com

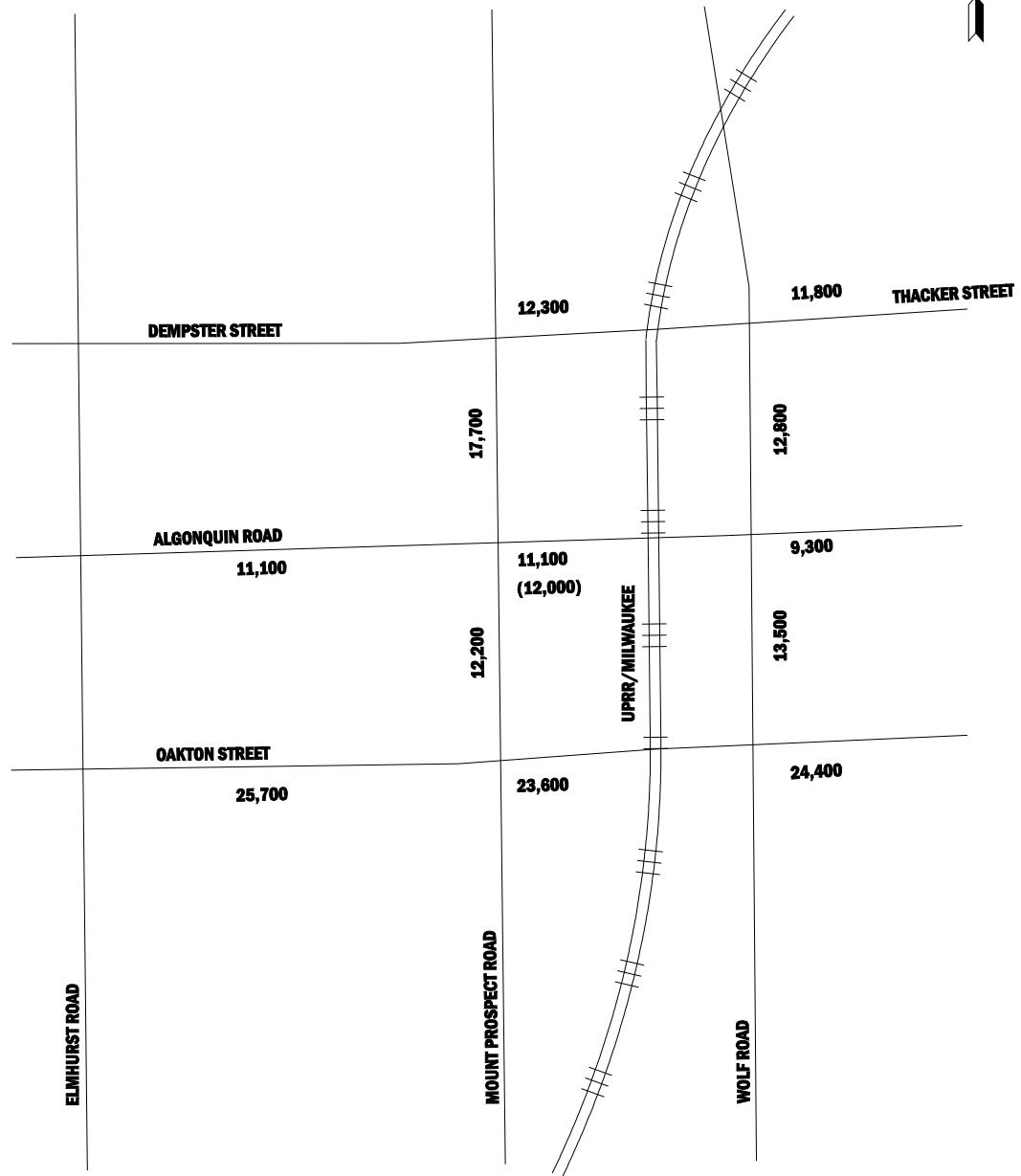
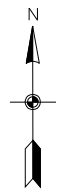

**AVERAGE DAILY TRAFFIC MAP**  
**EXISTING AND PROJECTED (YEAR 2030)**

**LEGEND**

- X,XXX**    **EXISTING**    **FROM IDOT TRAFFIC MAPS**
- (X,XXX)**    **PROJECTED**    **FROM CHICAGO METROPOLITAN AGENCY FOR PLANNING**



**Crash Summary by Accident Type**  
**Segment: Algonquin Rd from Mt. Prospect Road to Wolf Road**  
**2005 - 2007**

Existing ADT 11,100  
 Segment Length (miles) : 0.57

ACCIDENT TYPE	YEAR						TOTAL	
	2005		2006		2007		NO.	%
	NO.	%	NO.	%	NO.	%		
PEDESTRIAN							0	0
CYCLIST							0	0
RAILROAD TRAIN							0	0
ANIMAL							0	0
OVERTURNED							0	0
FIXED OBJECT			1	8	1	11	2	7.4
OTHER OBJECT							0	0
OTHER NON COLLISION							0	0
PARKED MOTOR VEHICLE							0	0
TURNING	1	20	1	8			2	7.4
REAR END	3	60	9	69	6	67	18	66.7
SIDESWIPE - SAME DIRECTION	1	20	1	8	1	11	3	11.1
SIDESWIPE - OPPOSITE DIRECTION					1	11	1	3.7
HEAD - ON			1	8			1	3.7
ANGLE							0	0
OTHER							0	0
<b>TOTAL</b>	<b>5</b>	<b>100</b>	<b>13</b>	<b>100</b>	<b>9</b>	<b>100</b>	<b>27</b>	<b>100</b>
ACCIDENTS INVOLVING INJURIES	0	0	0	0	1	1	1	3.7
ACCIDENTS INVOLVING FATALITIES	0	0	0	0	0	0	0	0

WET PAVEMENT: 22%  
 DARK CONDITION: 19%  
 ACCIDENT RATE: 2.34 Acc/MVM  
 FREQUENCY: 27

Acc/MVM: Accidents per million vehicles mile

Note:  
 Crash data provided by the City of Des Plaines

Crash Summary by Road Surface Condition  
 Segment: Algonquin Rd from Mt. Prospect Road to Wolf Road  
 2005 - 2007

ROAD SURFACE CONDITION	YEAR			TOTAL
	2005	2006	2007	
	NO.	NO.	NO.	NO.
DRY	4	10	7	21
WET	1	3	0	4
SNOW/ ICE	0	0	2	2
OTHER				
UNKNOWN				
TOTAL	5	13	9	27

WET ACCIDENTS	1	3	2	6
% OF TOTAL	20%	23%	22%	22%

Note:

Crash data provided by the City of Des Plaines

**Crash Summary by Road Lighting Condition**  
**Segment: Algonquin Rd from Mt. Prospect Road to Wolf Road**  
**2005 - 2007**

ROAD LIGHTING CONDITION	YEAR			TOTAL
	2005	2006	2007	
	NO.	NO.	NO.	NO.
DAYLIGHT	5	9	8	22
DAWN				
DUSK				
DARKNESS	2		1	3
DARKNESS, LIGHTED	0	2	0	2
UNKNOWN				
<b>TOTAL</b>	<b>7</b>	<b>11</b>	<b>9</b>	<b>27</b>

DARK ACCIDENTS	2	2	1	5
% OF TOTAL	29%	18%	11%	19%

Note:

Crash data provided by the City of Des Plaines

# Algonquin Road

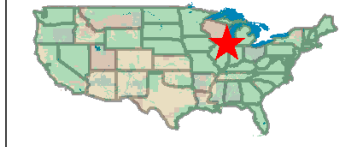
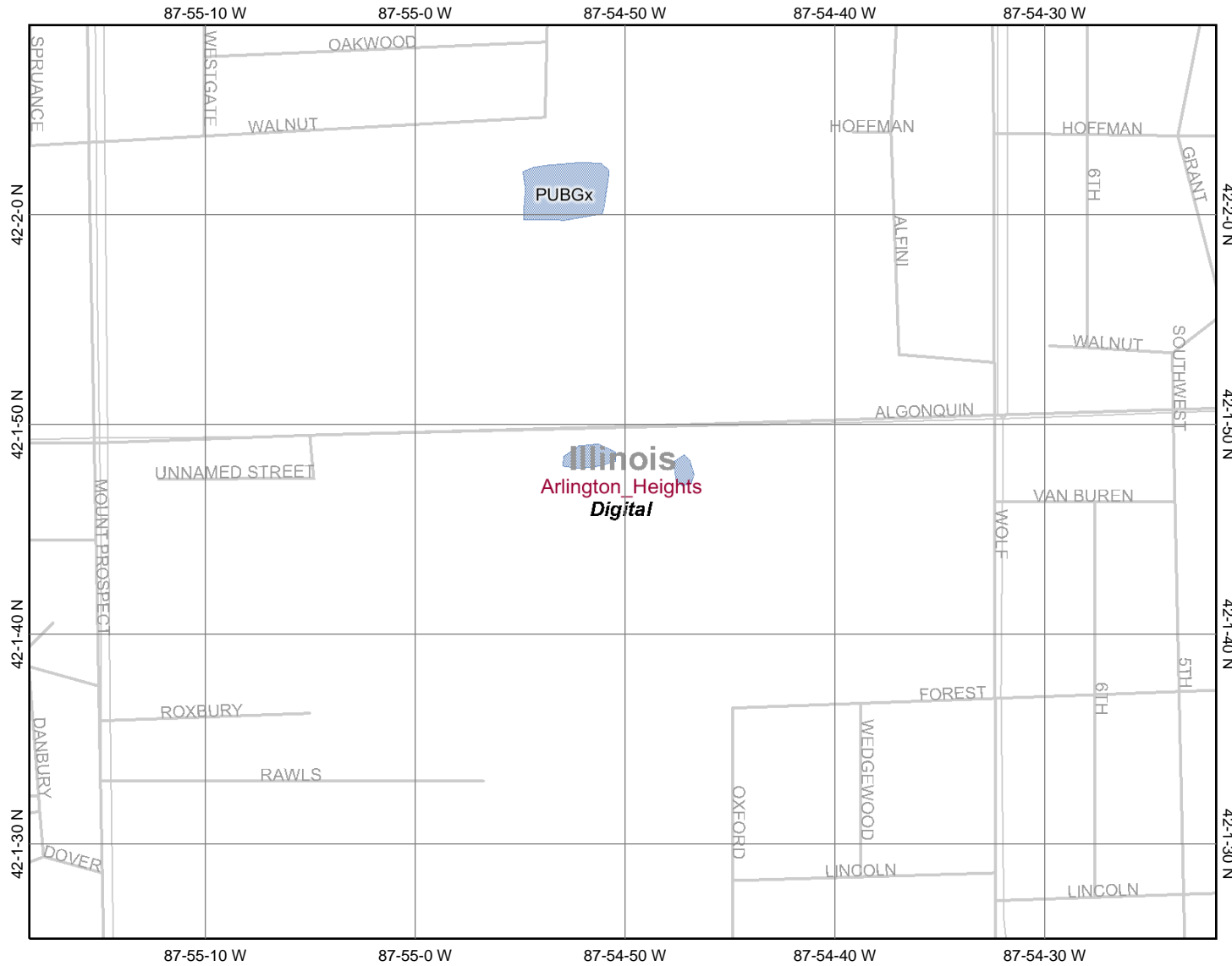

## Legend

- Ohio\_wet\_scan**
- 0
- 1
- Out of range
- Interstate**
- Major Roads**
- Other Road
- Interstate
- State highway
- US highway
- Roads**
- Cities**
- USGS Quad Index 24K
- Lower 48 Wetland Polygons**
- Estuarine and Marine Deepwater
- Estuarine and Marine Wetland
- Freshwater Emergent Wetland
- Freshwater Forested/Shrub Wetland
- Freshwater Pond
- Lake
- Other
- Riverine
- Lower 48 Available Wetland Data**
- Non-Digital
- Digital
- No Data
- Scan
- NHD Streams
- Counties 100K
- States 100K
- South America
- North America



Scale: 1:9,431

Map center: 42° 1' 47" N, 87° 54' 50" W

This map is a user generated static output from an Internet mapping site and is for general reference only. Data layers that appear on this map may or may not be accurate, current, or otherwise reliable. THIS MAP IS NOT TO BE USED FOR NAVIGATION.



MAP SCALE 1" = 500'

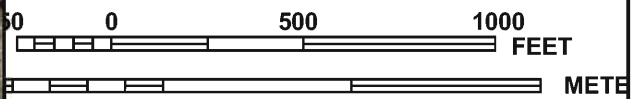

NATIONAL FLOOD INSURANCE PROGRAM  
 NFIP

PANEL 0216J

**FIRM**  
 FLOOD INSURANCE RATE MAP  
 COOK COUNTY,  
 ILLINOIS  
 AND INCORPORATED AREAS

**PANEL 216 OF 832**  
 (SEE MAP INDEX FOR FIRM PANEL LAYOUT)

CONTAINS:

COMMUNITY	NUMBER	PANEL	SUFFIX
DES PLAINES, CITY OF	170081	0216	J
MOUNT PROSPECT, VILLAGE OF	170129	0216	J

Notice to User: The Map Number shown below should be used when placing map orders, the Community Number shown above should be used on insurance applications for the subject community.



**MAP NUMBER**  
 17031C0216J  
**MAP REVISED**  
 AUGUST 19, 2008

Federal Emergency Management Agency

Mt. Prospect Road

UPRR/Milwaukee

UOP

R11E  
R12E

19

INS PANEL 0218

424000M E

This is an official copy of a portion of the above referenced flood map. It was extracted using F-MIT On-Line. This map does not reflect changes or amendments which may have been made subsequent to the date on the title block. For the latest product information about National Flood Insurance Program flood maps check the FEMA Flood Map Store at [www.msc.fema.gov](http://www.msc.fema.gov)



**City of  
Des Plaines  
170081**

UPRR/Milwaukee

**ZONE X**  
Park  
District

46° 54' 00.00" N

42° 01' 52.5"

87° 54' 22.5"



**MAP SCALE 1" = 500'**

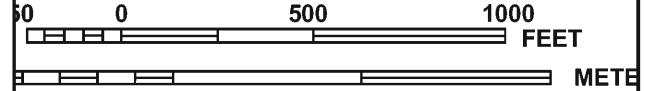

**NATIONAL FLOOD INSURANCE PROGRAM**

**PANEL 0216J**

**FIRM**  
FLOOD INSURANCE RATE MAP  
COOK COUNTY,  
ILLINOIS  
AND INCORPORATED AREAS

**PANEL 216 OF 832**

(SEE MAP INDEX FOR FIRM PANEL LAYOUT)

CONTAINS:

<u>COMMUNITY</u>	<u>NUMBER</u>	<u>PANEL</u>	<u>SUFFIX</u>
DES PLAINES, CITY OF	170081	0216	J
MOUNT PROSPECT, VILLAGE OF	170129	0216	J

Notice to User: The Map Number shown below should be used when placing map orders, the Community Number shown above should be used on insurance applications for the subject community.



**MAP NUMBER  
17031C0216J**  
**MAP REVISED  
AUGUST 19, 2008**

Federal Emergency Management Agency

This is an official copy of a portion of the above referenced flood map. It was extracted using F-MIT On-Line. This map does not reflect changes or amendments which may have been made subsequent to the date on the title block. For the latest product information about National Flood Insurance Program flood maps check the FEMA Flood Map Store at [www.msc.fema.gov](http://www.msc.fema.gov)



MAP SCALE 1" = 500'

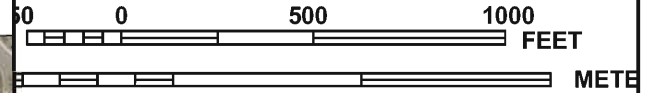

JOINS PANEL 0216



PANEL 0218J

**FIRM**  
FLOOD INSURANCE RATE MAP  
COOK COUNTY,  
ILLINOIS  
AND INCORPORATED AREAS

**PANEL 218 OF 832**

(SEE MAP INDEX FOR FIRM PANEL LAYOUT)

CONTAINS:

COMMUNITY	NUMBER	PANEL	SUFFIX
CHICAGO, CITY OF	170074	0218	J
COOK COUNTY	170054	0218	J
DES PLAINES, CITY OF	170081	0218	J
ELK GROVE VILLAGE, VILLAGE OF	170088	0218	J

Notice to User: The Map Number shown below should be used when placing map orders, the Community Number shown above should be used on insurance applications for the subject community.



**MAP NUMBER**  
**17031C0218J**

**MAP REVISED**  
**AUGUST 19, 2008**

Federal Emergency Management Agency

This is an official copy of a portion of the above referenced flood map. It was extracted using F-MIT On-Line. This map does not reflect changes or amendments which may have been made subsequent to the date on the title block. For the latest product information about National Flood Insurance Program flood maps check the FEMA Flood Map Store at [www.msc.fema.gov](http://www.msc.fema.gov)



MAP SCALE 1" = 500'

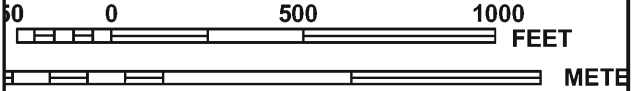

NATIONAL FLOOD INSURANCE PROGRAM  
 FEDERAL EMERGENCY MANAGEMENT AGENCY

PANEL 0218J

**FIRM**  
 FLOOD INSURANCE RATE MAP  
 COOK COUNTY,  
 ILLINOIS  
 AND INCORPORATED AREAS

**PANEL 218 OF 832**  
 (SEE MAP INDEX FOR FIRM PANEL LAYOUT)

CONTAINS:

COMMUNITY	NUMBER	PANEL	SUFFIX
CHICAGO, CITY OF	170074	0218	J
COOK COUNTY	170054	0218	J
DES PLAINES, CITY OF	170081	0218	J
ELK GROVE VILLAGE, VILLAGE OF	170088	0218	J

Notice to User: The Map Number shown below should be used when placing map orders, the Community Number shown above should be used on insurance applications for the subject community.



**MAP NUMBER**  
 17031C0218J  
**MAP REVISED**  
 AUGUST 19, 2008

Federal Emergency Management Agency

This is an official copy of a portion of the above referenced flood map. It was extracted using F-MIT On-Line. This map does not reflect changes or amendments which may have been made subsequent to the date on the title block. For the latest product information about National Flood Insurance Program flood maps check the FEMA Flood Map Store at [www.msc.fema.gov](http://www.msc.fema.gov)

EXHIBIT 8D



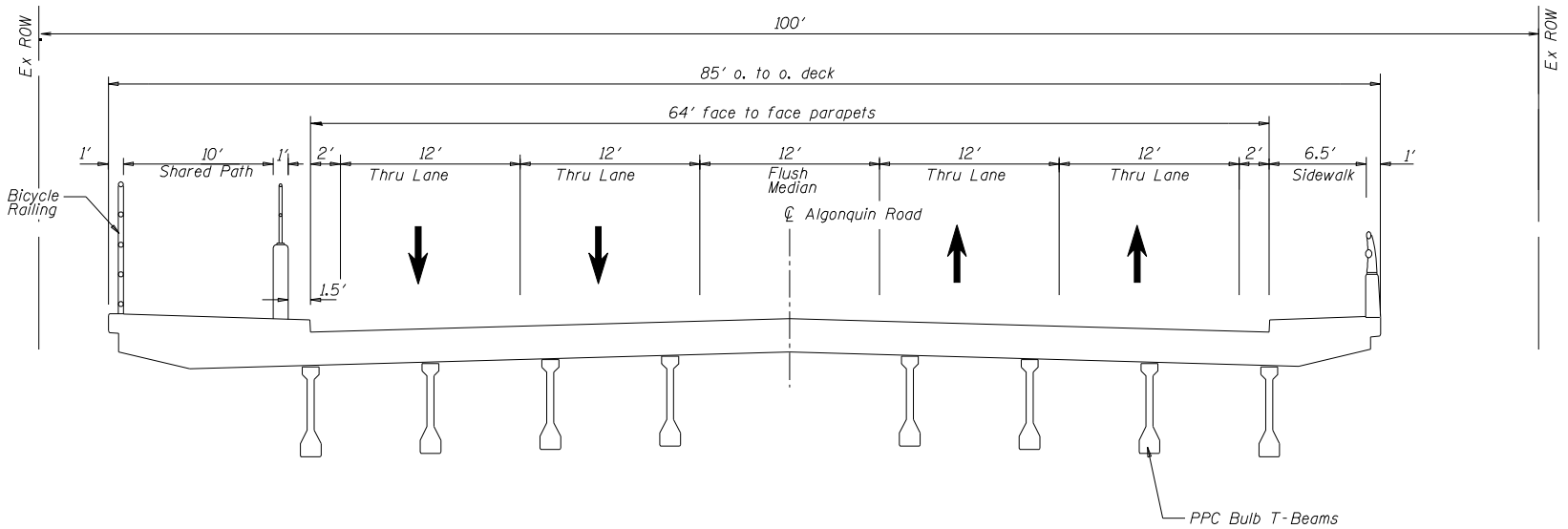

EXHIBIT 9

**PROPOSED TYPICAL SECTION**

ALTERNATE 1A , 1B

Algonquin Road  
Bridge over UPRR

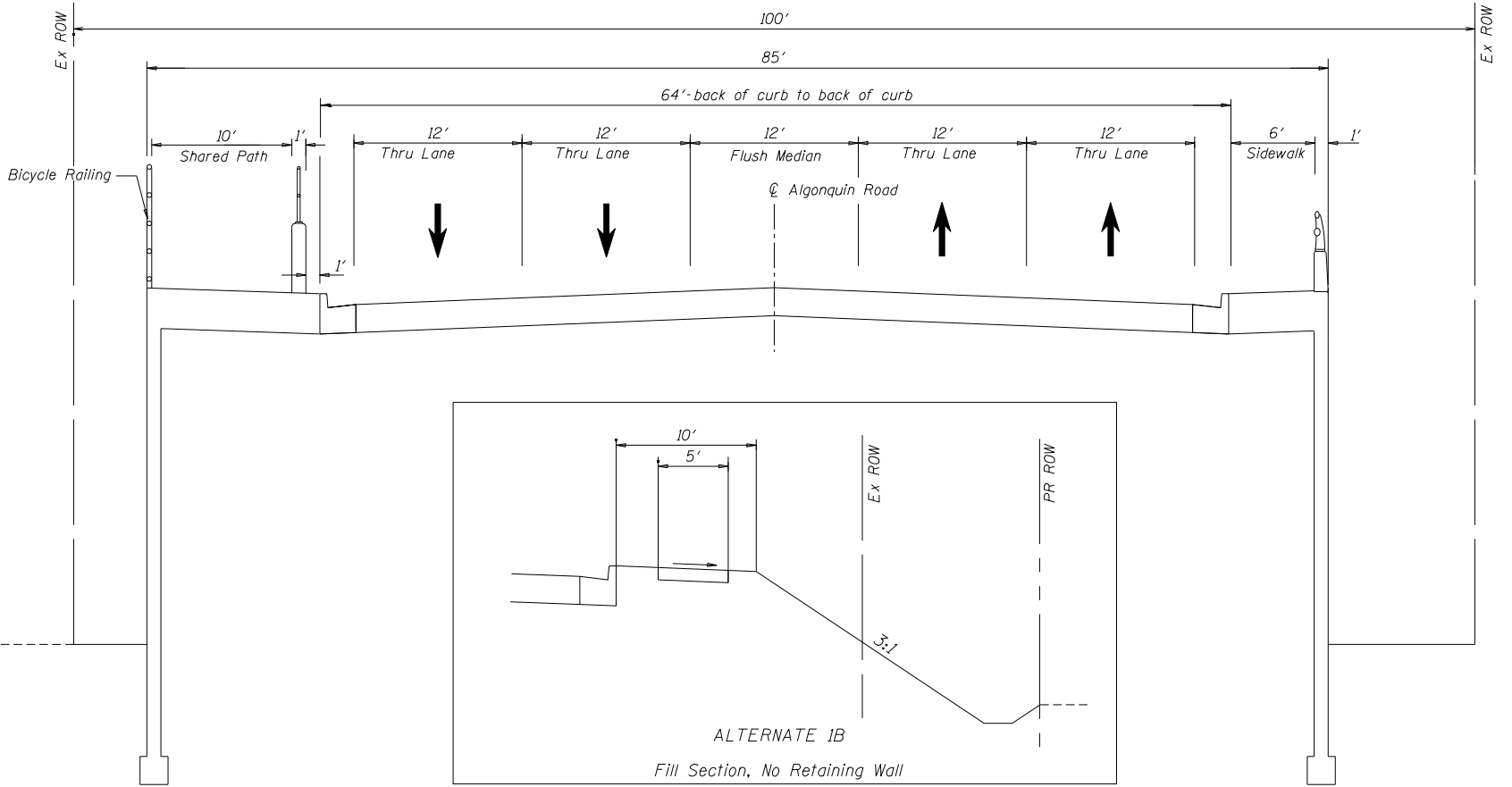

EXHIBIT 10

**PROPOSED TYPICAL SECTION**

ALTERNATE 1A

Algonquin Road  
Retaining Wall Locations

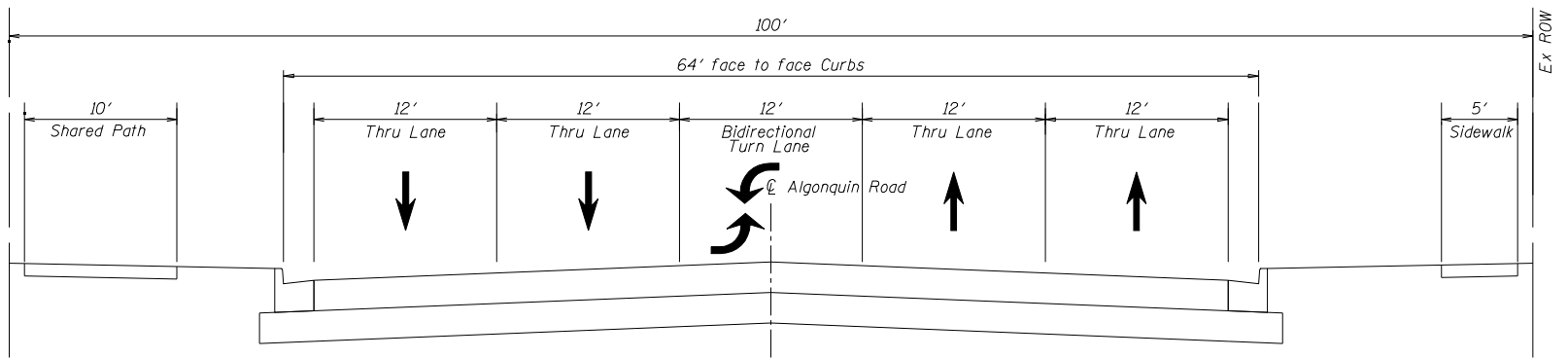
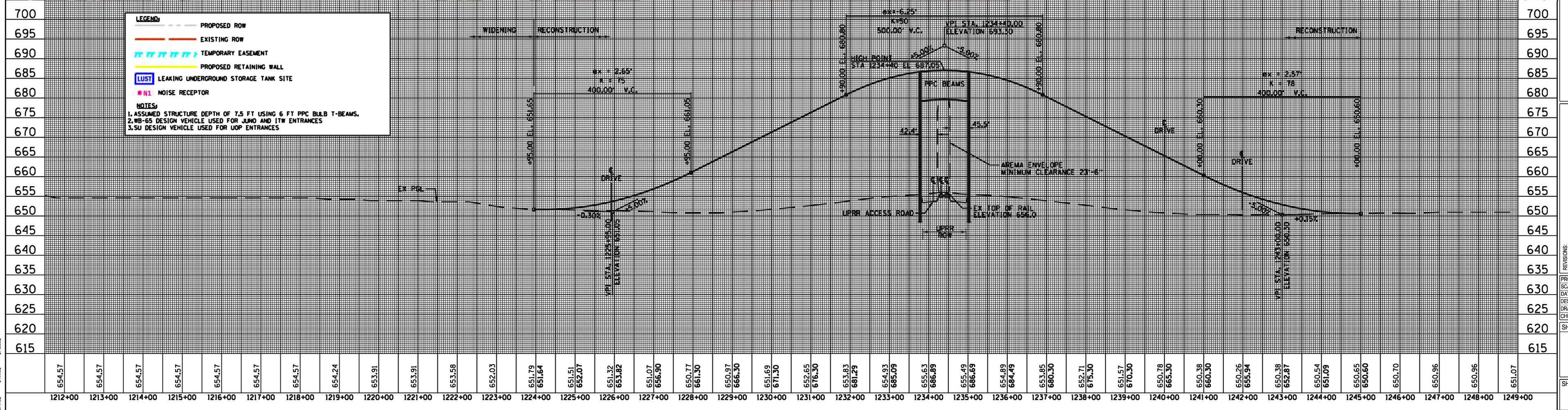
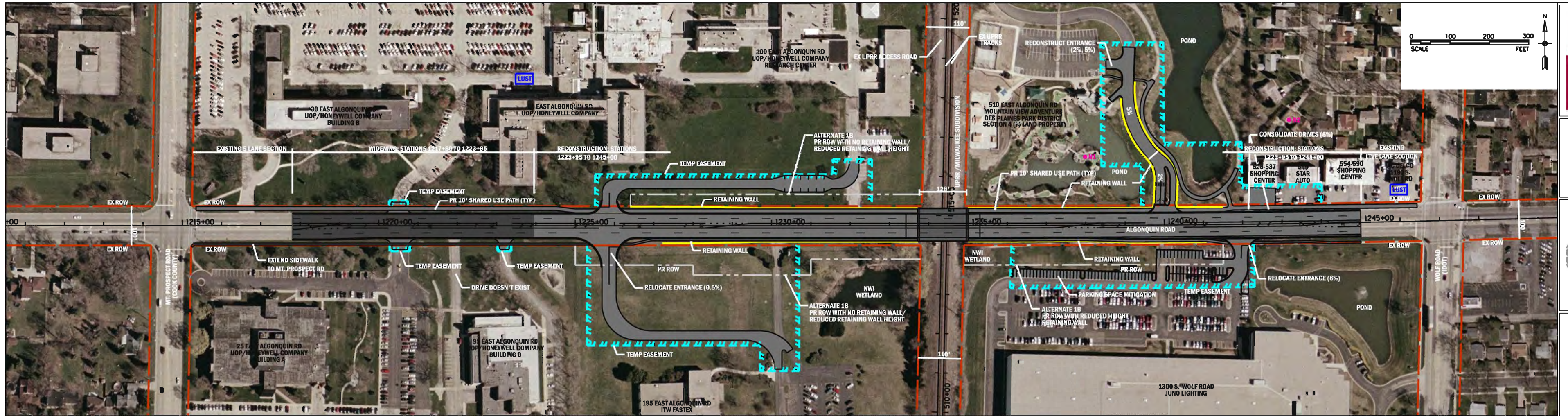

EXHIBIT 11

**PROPOSED TYPICAL SECTION**

ALTERNATES 1 & 2

Algonquin Road  
At-Grade Roadway



**LEGEND:**

- PROPOSED ROW
- EXISTING ROW
- TEMPORARY EASEMENT
- PROPOSED RETAINING WALL
- LUST LEAKING UNDERGROUND STORAGE TANK SITE
- NL NOISE RECEPTOR

**NOTES:**

1. ASSUMED STRUCTURE DEPTH OF 7.5 FT USING 6 FT PPC BULB T-BEAMS.
2. WB-65 DESIGN VEHICLE USED FOR JUNO AND ITW ENTRANCES
3. SU DESIGN VEHICLE USED FOR UOP ENTRANCES

REVISIONS	MARK	DATE	DESCRIPTION

IF THIS DRAWING IS LESS THAN 22" X 44" IT IS A REDUCED SIZE DRAWING

Ex ROW

Ex ROW

EXHIBIT 13

110'

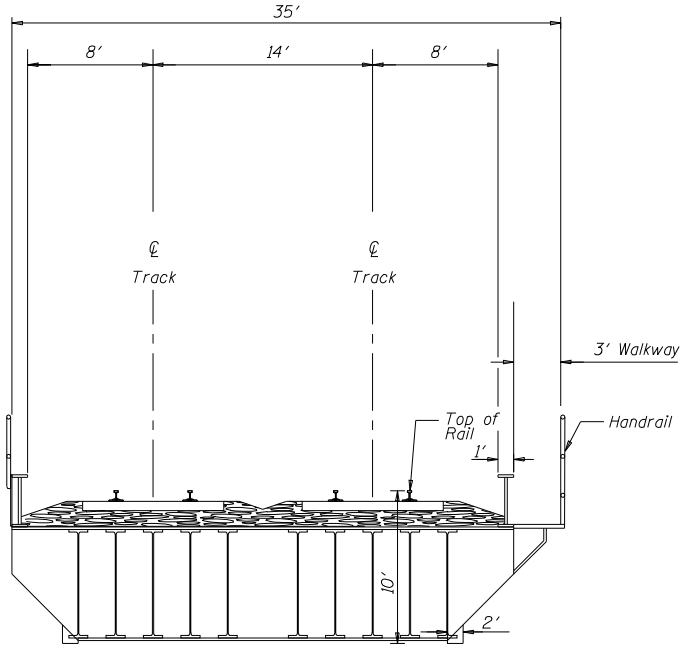

**PROPOSED TYPICAL SECTION**

ALTERNATES 2A & 2B

UPRR Deck Girder Bridge

UPRR/Milwaukee ROW

Deck Girder Bridge

Abutment

Abutment

14.75'

86' face to face Abutments

10' Shared Path 2' 1' 12' Thru Lane 12' Thru Lane 12' Flush Median 12' Thru Lane 12' Thru Lane 6' Sidewalk 2'

Algonquin Road



EXHIBIT 14

**PROPOSED TYPICAL SECTION**

ALTERNATE 2

Algonquin Road  
Under UPRR Through Girder Bridge

100'

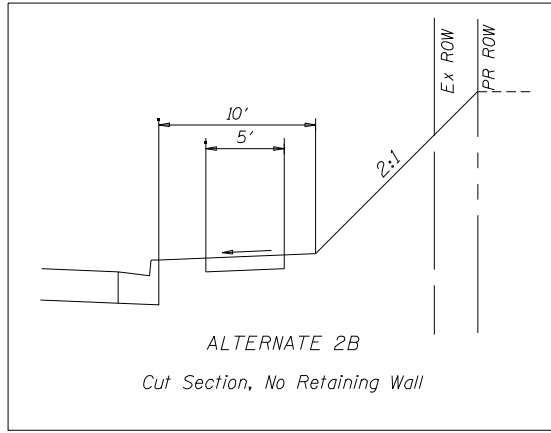

ALTERNATE 2B  
Cut Section, No Retaining Wall

86' face to face Retaining Walls

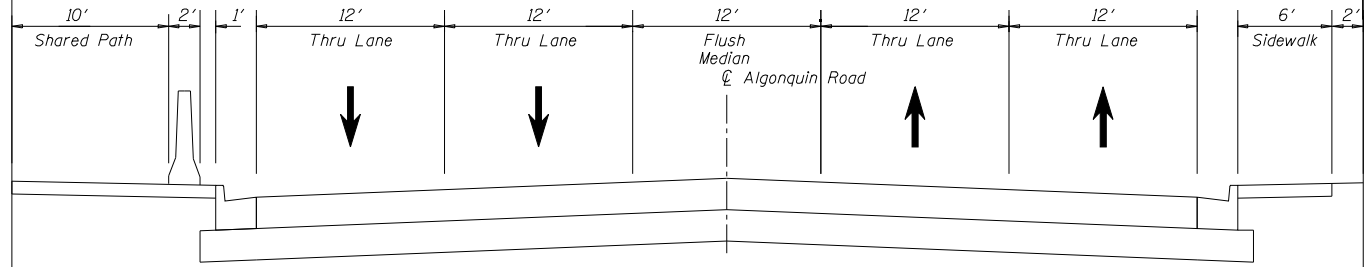

Ex ROW

Ex ROW

EXHIBIT 15

**PROPOSED TYPICAL SECTION**

ALTERNATE 2A  
Algonquin Road  
Depressed Roadway

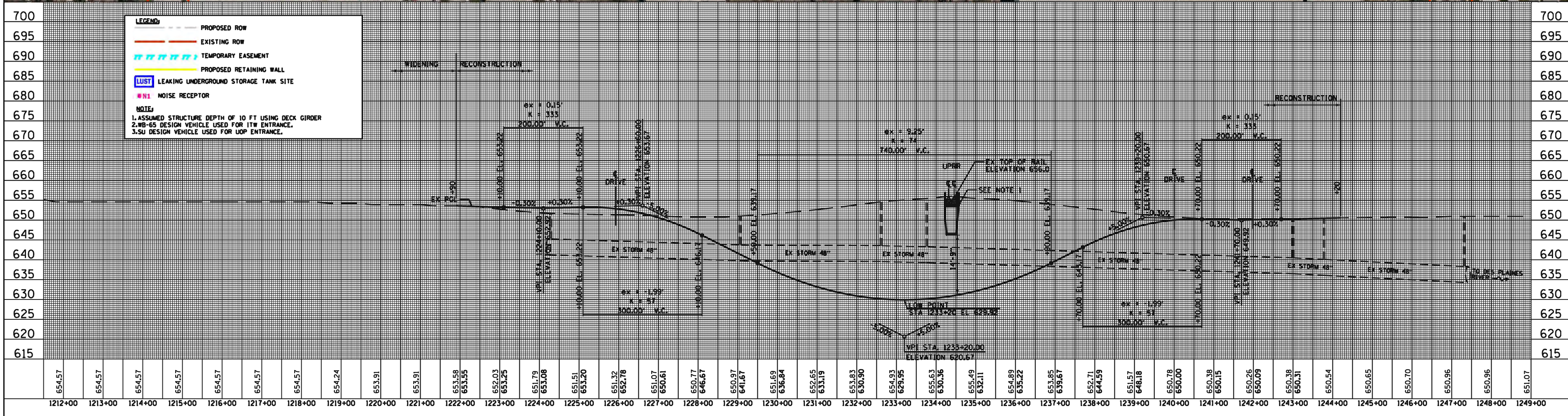
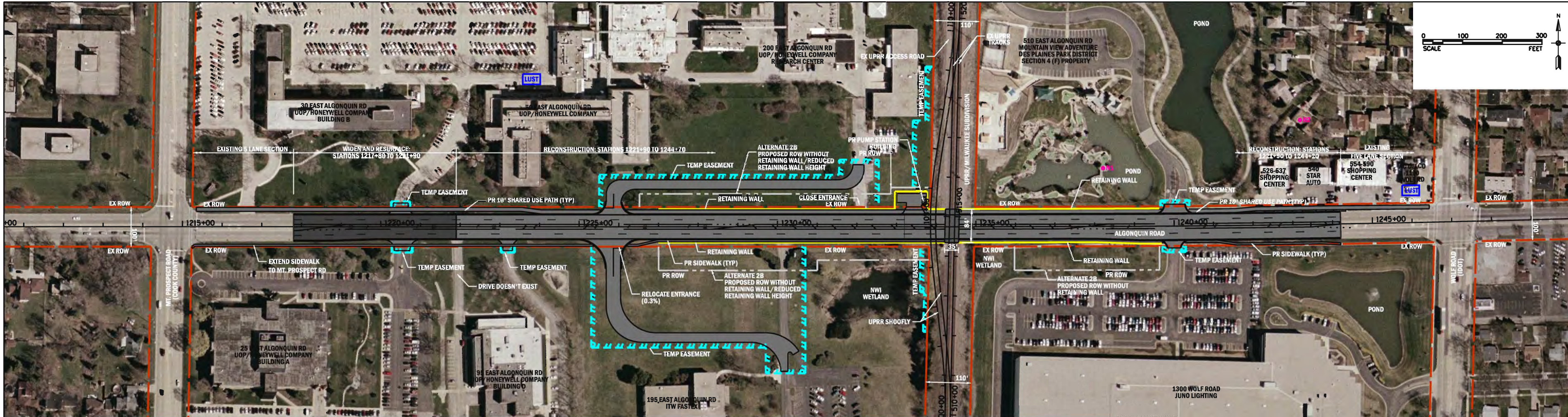

**LEGEND:**

- PROPOSED ROW
- EXISTING ROW
- TEMPORARY EASEMENT
- PROPOSED RETAINING WALL
- LUST LEAKING UNDERGROUND STORAGE TANK SITE
- #N1 NOISE RECEPTOR

**NOTE:**

1. ASSUMED STRUCTURE DEPTH OF 10 FT USING DECK GIRDER
2. WB-65 DESIGN VEHICLE USED FOR ITW ENTRANCE.
3. SU DESIGN VEHICLE USED FOR UOP ENTRANCE.

REVISIONS	MARK	DATE	DESCRIPTION

IF THIS DRAWING IS LESS THAN 22" X 44" IT IS A REDUCED SIZE DRAWING



**ALTERNATIVE COMPARISON MATRIX**

January 2009

	Constructability / Traffic Control / Staging/	Drainage Requirements / Utility Impacts	Railroad Impacts	Economic/ROW Impacts	Environmental Impacts <sup>1</sup>	Pedestrian / Bicycle / Mass Transit <sup>2</sup>	Cost / Funding Opportunities	Advantages	Disadvantages
<b>Alternative No. 1</b> Algonquin Rd Over UPRR  1A: Full height retaining walls  1B: Side slopes and reduced height retaining walls	Close Algonquin Rd to thru traffic  One construction season.  Construct east half first for Park District entrance.	Reconstruct SS, Sanitary and WM  Relocate ComEd OH south side Algonquin Road  Relocate ComEd OH east side UPRR  Relocate UPRR OH west side UPRR	Remove warning devices	1A: ROW (0 parcels) 1B: ROW (3 parcels) TE ( 9 parcels)  Relocate drives (3) Consolidate drive (1)  Parking spaces to be mitigated: UOP: 10 Juno: 1A (20); 1B (40)	LUST (5)  CERCLIS (1)  NWI Wetlands (0)  Section 4(f) (1)	No PACE Routes within project limits  Proposed bicycle route.  Proposed sidewalks north and south side	1A: \$27,434,520  1B: \$27,316,620	Least degree of coordination with UPRR.  Minimal interruption to UPRR.  Landscaped side slopes for Alternate 1B lessen the unsightliness of tall wall.  UPRR preferred alternate  Blocks Park District views of industrial buildings south of Algonquin Road	Reconstruction of Park District driveway on retaining wall resulting in 1 month closure.  Obstructive views from 30' tall retaining wall  Alternate 1B has significant ROW acquisition  City maintains substructure and superstructure including deck.
<b>Alternative No. 2</b> Algonquin Rd Under UPRR  1A: Full height retaining walls  1B: Side slopes and reduced height retaining walls	Close Algonquin Rd to thru traffic  One construction season  Algonquin Road construction depends on UPRR work completion	Pump station  Reconstruct SS, Sanitary and WM  Relocate ComEd OH south side Algonquin Road  Relocate ComEd OH east side UPRR  Relocate UPRR OH and Level 3 west side UPRR	Shoofly required  Remove warning devices  New track over bridge	2A:ROW (1 parcel) 2B:ROW (3 parcels) TE ( 7 parcels)  Relocate drives (2)  Parking spaces to be mitigated at UOP: 10	LUST (5)  CERCLIS (1)  NWI Wetlands (2)	No PACE Routes within project limits  Proposed bicycle route.  Proposed sidewalks north and south side	2A: \$29,786,750  2B: \$28,941,550	Less impacts to adjacent properties than Alternate 1.  No obstructed views.  Better future land-use option.  No Section 4(f) Involvement  UPRR maintains bridge above waterproofing membrane.	Pump station required.  Pump station maintenance  Shoofly required  Alternate 2B has increased drainage area.  Alternate 2B has significant ROW acquisition  Possible maintenance issues with ponds/wetlands near underpass.  Significant UPRR involvement  City maintains substructure and superstructure below waterproofing membrane
<b>Alternative No. 3</b> Algonquin Rd Under UPRR with Track Raise	Close Algonquin Rd to thru traffic  One construction season  Algonquin Road construction depends on UPRR work completion	Reconstruct SS, Sanitary and WM  Relocate ComEd OH south side Algonquin Road  Relocate ComEd OH east side UPRR  Relocate UPRR OH and Level 3 west side UPRR	Shoofly required  Track raise; new track  Remove warning devices	ROW (0 parcels) TE ( 10+ parcels)  Relocate drives (2)	LUST (5)  CERCLIS (1)  NWI Wetlands (2)  Section 4(f) (1)	No PACE Routes within project limits  Proposed bicycle route.  Proposed sidewalks north and south side	\$48,201,290	No pump station required.  Limited obstructed views.  UPRR maintains bridge above waterproofing membrane.	Most adjacent property impacts  Greatest degree of coordination with UPRR. Significant UPRR involvement  City maintains substructure and superstructure below waterproofing membrane  Longer shoofly required  Major track raise (>2')  Most expensive

<sup>1</sup> Environmental impacts considered include NWI Wetlands, floodplain, T&E, 4(f) lands and special waste. LUST sites are within 1,100 feet of project limits. CERCLIS sites are within 1 mile of project limits.

<sup>2</sup> PACE route #230 exists along Algonquin Road west of Mt. Prospect Road. Other PACE routes exist adjacent to project limits.

**Algonquin Road Closed**  
 To Through Traffic  
 Mt Prospect Road to Wolf Road

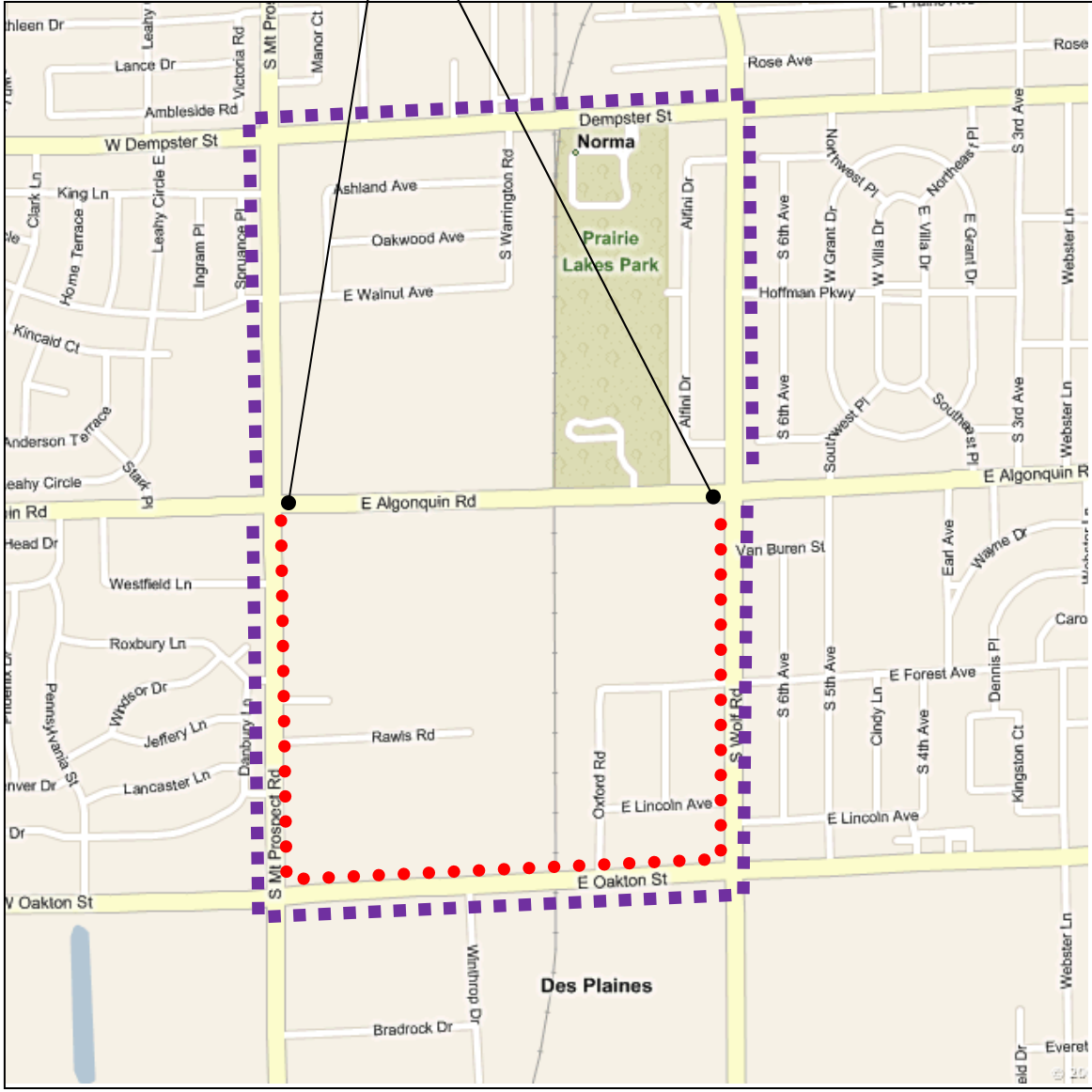

**Legend**

- ● ● ● ● Detour Route: Suggested Truck Route
- ■ ■ ■ ■ Detour Route: All Vehicles Except Trucks

**EXHIBIT 18**



**DETOUR MAP**

Algonquin Road Grade Separation  
 at the UPRR Milwaukee Subdivision  
 Mount Prospect Road to Wolf Road  
 City of Des Plaines



1051 Perimeter Drive, Suite 1025  
 Schaumburg, Illinois 60173  
 (847) 605-9600 | (847) 605-9610 Fax  
 www.transystems.com



CONCEPTUAL ESTIMATE OF COST

Date: January 2009 (Final)

Item	Unit	Unit Price	ALTERNATE NO. 1				ALTERNATE NO. 2				ALTERNATE NO. 3	
			Alternate No. 1A Algonquin Rd Over UPRR (Retaining Walls)		Alternate No. 1B Algonquin Rd Over UPRR (Side Slopes)		Alternate No. 2A Algonquin Rd Under UPRR (Retaining Walls)		Alternate No. 2B Algonquin Rd Under UPRR (Side Slopes)		Alternate No. 3 Algonquin Rd Under UPRR/Track Raise	
			Quantity	Total Cost	Quantity	Total Cost	Quantity	Total Cost	Quantity	Total Cost	Quantity	Total Cost
<b>Removals and Relocations</b>			(1%)	\$257,180	(1%)	\$257,180	(1%)	\$203,300	(1%)	\$203,300	(1%)	\$205,500
• Pavement Removal	Sq Yd	\$15	8,500	127,500	8,500	127,500	9,100	136,500	9,100	136,500	10,100	151,500
• HMA Surface Removal	Sq Yd	\$4	4,670	18,680	4,670	18,680	2,700	10,800	2,700	10,800	0	0
• Curb & Gutter Removal	Foot	\$5	1,200	6,000	1,200	6,000	400	2,000	400	2,000	1,200	6,000
• Sidewalk Removal	Sq Ft	\$3	13,000	39,000	13,000	39,000	8,000	24,000	8,000	24,000	13,000	39,000
• Sewer Removal (SS and San)	Foot	\$15	4,400	66,000	4,400	66,000	2,000	30,000	2,000	30,000	600	9,000
<b>Earthwork</b>			(12%)	\$2,460,000	(16%)	\$3,280,000	(7%)	\$1,637,500	(10%)	\$2,262,500	(3%)	\$1,340,000
• Earth Excavation	Cu Yd	\$25	2,000	50,000	4,000	100,000	53,500	1,337,500	78,500	1,962,500	41,600	1,040,000
• Furnished Excavation	Cu Yd	\$20	118,000	2,360,000	156,500	3,130,000	0	0	0	0	0	0
• Special Waste Removal	Ton	\$100	500	50,000	500	50,000	3,000	300,000	3,000	300,000	3,000	300,000
<b>Pavement</b>			(10%)	\$2,014,840	(10%)	\$2,014,840	(8%)	\$1,813,950	(8%)	\$1,813,950	(5%)	\$1,812,520
• Pavement	Sq Yd	\$60	14,033	842,000	14,033	842,000	15,250	915,000	15,250	915,000	16,700	1,002,000
• Aggregate Subgrade 12"	Sq Yd	\$14	21,300	298,200	21,300	298,200	21,900	306,600	21,900	306,600	21,100	295,400
• Curb & Gutter	Foot	\$16	5,400	86,400	5,400	86,400	5,400	86,400	5,400	86,400	5,270	84,320
• PCC Sidewalk 5"	Sq Ft	\$5	15,650	78,250	15,650	78,250	14,400	72,000	14,400	72,000	14,400	72,000
• HMA Bicycle Path	Sq Ft	\$4	37,300	149,200	37,300	149,200	31,200	124,800	31,200	124,800	31,200	124,800
• Bridge Approach Pavement	Sq Yd	\$200	375	75,000	375	75,000	0	0	0	0	0	0
• Driveway/Pk Lot Pavement	Sq Yd	\$45	8,300	373,500	8,300	373,500	5,200	234,000	5,200	234,000	5,200	234,000
• Pavement Widening + Subbase	Sq Yd	\$75	830	62,250	830	62,250	570	42,750	570	42,750	0	\$0
• Pavement Resurfacing	Sq Yd	\$12	4,170	50,040	4,170	50,040	2,700	32,400	2,700	32,400	0	\$0
<b>Structural</b>			(49%)	\$10,240,000	(35%)	\$7,404,000	(42%)	\$9,872,000	(32%)	\$7,550,000	(27%)	\$10,472,000
• Bridge (72" PPC Bulb T-Beams)	Sq Ft	\$125	10,200	1,275,000	10,200	1,275,000	0	0	0	0	0	0
• Bridge (10' Deck Girder)	Track Foot	\$24,000	0	0	0	0	180	4,320,000	180	4,320,000	240	5,760,000
• Underpass Lighting	L Sum	\$30,000	0	0	0	0	1	30,000	1	30,000	1	30,000
• Retaining Walls - Algonquin Rd	Sq Ft	\$100	74,150	7,415,000	48,550	4,855,000	50,000	5,000,000	29,800	2,980,000	41,600	4,160,000
• Retaining Walls - Park District	Sq Ft	\$100	9,300	930,000	9,300	930,000	0	0	0	0	0	0
• Railing	Foot	\$200	3,100	620,000	1,720	344,000	2,610	522,000	1,100	220,000	2,610	522,000
<b>Stormwater &amp; Public Utilities</b>			(6%)	\$1,287,500	(6%)	\$1,287,500	(16%)	\$3,657,000	(16%)	\$3,657,000	(3%)	\$1,086,500
• Storm Sewer, 24"	Foot	\$90	0	0	0	0	0	0	0	0	2,400	216,000
• Storm Sewer, 48"	Foot	\$130	2,200	286,000	2,200	286,000	1,000	130,000	1,000	130,000	0	0
• Storm Sewer, 60"	Foot	\$160	1,000	160,000	1,000	160,000	0	0	0	0	1,300	208,000
• Laterals, 12"	Foot	\$50	200	10,000	200	10,000	200	10,000	200	10,000	200	10,000
• Drainage Structures	Each	\$1,500	21	31,500	21	31,500	18	27,000	18	27,000	15	22,500
• Trench Backfill	Cu Yd	\$30	1,000	30,000	1,000	30,000	0	0	0	0	0	0
• Pump Station + Detention System	L Sum	\$3,000,000	0	0	0	0	1	3,000,000	1	3,000,000	0	0
• Water Main, 10"	Foot	\$200	2,200	440,000	2,200	440,000	1,700	340,000	1,700	340,000	2,700	\$540,000
• Sanitary Sewer, 18"	Foot	\$150	2,200	330,000	2,200	330,000	1,000	150,000	1,000	150,000	600	\$90,000

Item	Unit	Unit Price
<b>Railroad</b>		
• Furnished Excavation	Cu Yd	\$25
• Excavation	Cu Yd	\$30
• Shoo Fly (Install & Remove)	Track Foot	\$300
• Temporary Sheet Piling	Sq Ft	\$45
• Install Track Complete	Foot	\$200
• Subballast	Cu Yd	\$20
• Flaggers	Day	\$600
• Retaining Wall	Sq Ft	\$100
• Signal Bungalow Replacement	L Sum	\$250,000
<b>Miscellaneous</b>		
• Landscaping	L Sum	\$70,000
• Pavement Marking & Signing	L Sum	\$25,000
• Erosion Control	L Sum	\$55,000
<b>Subtotal --Construction</b>		
Maintenance of Traffic	%	0.5%
Mobilization	%	6%
Contingency	%	20%
<b>TOTAL - CONSTRUCTION</b>		
<b>Right-of-Way</b>		
• Acquisition	Sq Ft	\$25
• Permanent Easement	Sq Ft	\$10
• Temporary Easement	Sq Ft	\$5
<b>Environmental</b>		
• Wetland Mitigation	Acre	\$150,000
<b>Private Utility Relocation (UPRR ROW)</b>		
• ComEd Power Poles	L Sum	\$100,000
• UPRR Power Poles	Each	\$5,000
• Level 3 Fiber Optic	Foot	\$1,000
Design Engineering	%	10%
Construction Engineering	%	12%
<b>TOTAL PROJECT COST</b>		

Alternate No. 1A Algonquin Rd Over UPRR (Retaining Walls)		Alternate No. 1B Algonquin Rd Over UPRR (Side Slopes)	
Quantity	Total Cost	Quantity	Total Cost
(0%)	\$103,500	(0%)	\$103,500
0	0	0	0
0	0	0	0
0	0	0	0
1,500	67,500	1,500	67,500
0	0	0	0
0	0	0	0
60	36,000	60	36,000
0	0	0	0
0	0	0	0
(1%)	\$150,000	(1%)	\$150,000
1	70,000	1	70,000
1	25,000	1	25,000
1	55,000	1	55,000
(79%)	\$16,513,020	(69%)	\$14,497,020
1	\$83,000	1	\$83,000
1	\$991,000	1	\$870,000
1	\$3,303,000	1	\$2,900,000
(100%)	\$20,890,020	(90%)	\$18,350,020
0	\$1,947,500	122,300	\$4,927,600
0	0	0	0
15,000	150,000	15,000	150,000
359,500	1,797,500	344,020	1,720,100
0.0	\$0	0.0	\$0
1	\$120,000	1	\$120,000
1	100,000	1	100,000
4	20,000	4	20,000
0	0	0	0
1	\$2,090,000	1	\$1,836,000
1	\$2,507,000	1	\$2,203,000
<b>\$27,434,520</b>		<b>\$27,316,620</b>	

Alternate No. 2A Algonquin Rd Under UPRR (Retaining Walls)		Alternate No. 2B Algonquin Rd Under UPRR (Side Slopes)	
Quantity	Total Cost	Quantity	Total Cost
(5%)	\$1,197,000	(5%)	\$1,197,000
0	0	0	0
0	0	0	0
2,200	660,000	2,200	660,000
3,000	135,000	3,000	135,000
200	40,000	200	40,000
200	4,000	200	4,000
180	108,000	180	108,000
0	0	0	0
1	250,000	1	250,000
(1%)	\$150,000	(1%)	\$150,000
1	70,000	1	70,000
1	25,000	1	25,000
1	55,000	1	55,000
(79%)	\$18,530,750	(72%)	\$16,833,750
1	\$93,000	1	\$85,000
1	\$1,112,000	1	\$1,011,000
1	\$3,707,000	1	\$3,367,000
(100%)	\$23,442,750	(93%)	\$21,296,750
2,400	\$1,185,000	69,300	\$2,958,800
0	60,000	0	1,732,500
0	0	0	0
225,000	1,125,000	245,260	1,226,300
1.0	\$150,000	1.0	\$150,000
1	\$320,000	1	\$320,000
1	100,000	1	100,000
4	20,000	4	20,000
200	200,000	200	200,000
1	\$2,345,000	1	\$2,130,000
1	\$2,814,000	1	\$2,556,000
<b>\$29,786,750</b>		<b>\$28,941,550</b>	

Alternate No. 3 Algonquin Rd Under UPRR/Track Raise	
Quantity	Total Cost
(40%)	\$15,464,770
26,444	661,103
13,542	406,268
10,500	3,150,000
30,000	1,350,000
9,300	1,860,000
9,370	187,400
250	150,000
74,500	7,450,000
1	250,000
(0%)	\$150,000
1	\$70,000
1	\$25,000
1	\$55,000
(79%)	\$30,531,290
1	\$153,000
1	\$1,832,000
1	\$6,107,000
(100%)	\$38,623,290
0	\$1,080,000
0	0
216,000	1,080,000
2.0	\$300,000
1	\$1,140,000
1	\$100,000
8	\$40,000
1,000	\$1,000,000
1	\$3,863,000
1	\$4,635,000
<b>\$48,201,290</b>	

Item	Unit	Unit Price	Alternate No. 1A Algonquin Rd Over UPRR (Retaining Walls)		Alternate No. 1B Algonquin Rd Over UPRR (Side Slopes)		Alternate No. 2A Algonquin Rd Under UPRR (Retaining Walls)		Alternate No. 2B Algonquin Rd Under UPRR (Side Slopes)		Alternate No. 3 Algonquin Rd Under UPRR/Track Raise	
			Quantity	Total Cost	Quantity	Total Cost	Quantity	Total Cost	Quantity	Total Cost	Quantity	Total Cost

**Assumptions**

1. Limits of sewer removal and replacement are limited to reconstruction area.
2. Earth excavation includes roadway cut plus 2 foot cut in proposed widening locations.
3. Embankment under roadway on retaining wall sections is assumed from wall to wall. Depending on wall type select backfill may be required, be deducted from this value, and included in retaining wall cost.
4. Special waste assumed at 1 percent of excavation at 120 lb/cf.
5. Retaining wall assumed to be 4 feet below grade and 1.5 feet above proposed need.
6. Laterals and drainage structures assumed every 300 feet.
7. In-line detention assumed for Alternates 1 and 3 for increase in impervious area.
8. Pump station and detention cost from 2002 US 14 study. No provisions for downstream drainage improvements or maintenance costs have been provided.
9. Water main and sanitary sewer costs are all inclusive.

**Project Limits**

**Station to Station**

**Length**

**Alternate No. 1**

Widen/Resurface:	1217+80	1223+95	615 ft	(0.12 mi)
Reconstruction:	1223+95	1245+00	<u>2,105 ft</u>	<u>(0.40 mi)</u>
<b>Total - Algonquin Road</b>			<b>2,720 ft</b>	<b>(0.52 mi)</b>
<b>Total - UPRR/Milwaukee</b>	-	-	<b>0 ft</b>	<b>(0.00 mi)</b>

**Alternate No. 2**

Widen/Resurface:	1217+80	1221+90	410 ft	(0.08 mi)
Reconstruction:	1221+90	1244+20	2,230 ft	(0.42 mi)
<b>Total - Algonquin Road</b>			<b>2,640 ft</b>	<b>(0.50 mi)</b>
<b>Total - UPRR/Milwaukee</b>	1021+60	1032+70	<b>1,110 ft</b>	<b>(0.21 mi)</b>

**Alternate No. 3**

Reconstruction:	1217+80	1244+20	<u>2,640 ft</u>	<u>(0.50 mi)</u>
<b>Total - Algonquin Road</b>			<b>2,640 ft</b>	<b>(0.50 mi)</b>
<b>Total - UPRR/Milwaukee</b>	1005+90	1049+00	<b>4,310 ft</b>	<b>(0.82 mi)</b>

## FUNDING OPPORTUNITIES

January 2009

Program	Sponsor Agency	Funding Participation	Maximum Funding Level	Targeted for Alt 1 & 2	Eligible Elements	Eligible Projects	Selection Criteria	Schedule	Success Rating
Congestion Mitigation and Air Quality (CMAQ)	Chicago Metropolitan Agency for Planning (CMAP)	80% Federal 20% Local	No maximum, but high costs impact ranking	\$1,000,000	Engineering, right-of-way, and construction (Must follow federal process thru IDOT)	Traffic flow or bicycle/pedestrian improvements	Ranking, readiness, and project mix. Adding lanes may reduce possibility.	Call for applications typically at end of every January. Selection in Fall.	Good / <b>Fair</b> / Poor
Grade Crossing Protection Fund (GCPF)	Illinois Commerce Commission (ICC)	With federal funds: Up to 60% for grade separations.  Without federal funds: 60%	\$12M (maximum) (\$27M annually)	\$12,000,000	Pre-construction, construction	Construction or upgrade of crossing protection. Construction or improvement of any highway necessary for access to property due to a crossing closure. Construction, reconstruction, relocation or removal of grade separate structures.	Review by ICC Rail Safety Section Cannot be used on State Highways.	Petition can be made anytime. Public hearing is necessary. Selection time around two months after hearing.	<b>Good</b> / Fair / Poor
Illinois Transportation Enhancement Program (ITEP)	Illinois Department of Transportation (IDOT)	80% Federal 20% Local	No maximum (\$60M annually)	\$1,000,000	Engineering, right-of-way, and construction (Must follow federal process thru IDOT)	Enhancements such as landscaping, bike path or decorative lighting	Project merits as determined by selection committee	Call for applications are typically in Fall. Selections may take up to 1 year.	Good / <b>Fair</b> / Poor
SAFETE-LU Federal Reauthorization Earmark	Federal Highway Administration (FHWA) / IDOT	90% Federal 10% Local	No maximum (\$350M annually)	\$20,000,000	All components	Local rail line relocation and improvements	Local political representatives	Current program expires in 2009. Future program to be determined.	Good / <b>Fair</b> / Poor
Highway Safety Improvement Program (HSIP)	FHWA / IDOT	90% Federal 10% Local	No maximum (\$8M annually)	\$0	Pre-construction and construction	Projects that reduce crashes at public highway-rail grade crossings	Reduction potential for fatalities	Applications in November with selections in the following Spring.	Good / Fair / <b>Poor</b>
Motor Fuel Tax (MFT)	IDOT	100%	No maximum (\$600M annually)	\$2,000,000	Engineering, right-of-way, and construction	General roadway improvements, bike paths, grade separations	Local decision with IDOT approval	City must adopt resolution.	<b>Good</b> / Fair / Poor
Jurisdictional Transfer	IDOT	Varies	No maximum. Depends on supplemental funding.	\$2,000,000	Phase I, II, III engineering and construction	State roadways that are transferred to local jurisdictions.	Local decision with IDOT approval. May not fund grade separation elements.	City must adopt resolution.	<b>Good</b> / Fair / Poor
Surface Transportation Program (STP)	Northwest Municipal Conference	70% Federal / 30% Local (50/50 for ROW)	\$2.5M excluding ROW (\$150M annually)	\$2,500,000	Phase III engineering, right-of-way, and construction (Must follow federal process thru IDOT)	General roadway improvements on collector or higher	Need Phase I completed	Call for applications are typically every Fall.	<b>Good</b> / Fair / Poor

Program	Sponsor Agency	Funding Participation	Maximum Funding Level	Targeted Amount for Alt 1	Eligible Elements	Eligible Projects	Selection Criteria	Schedule	Success Rating
Municipal Improvement Program (CIP)	City of Des Plaines	Varies	Not applicable	\$2,000,000	All components	City projects	City Council	Fiscal year	<b>Good</b> / Fair / Poor
Union Pacific Railroad	Union Pacific Railroad (UPRR)	5% of bridge construction within vertical tie-in.	Not applicable	\$1,000,000	Preliminary engineering, right-of-way and construction	Railroad involved	As directed by ICC	Tied to ICC stipulated agreement	<b>Good</b> / Fair / Poor





APPENDIX B  
COORDINATION



## MINUTES OF MEETINGS





TranSystems

1051 Perimeter Drive  
Suite 1051  
Schaumburg, IL 60173-5058  
Tel 847.605.9600  
Fax 847.605.9610

[www.transystems.com](http://www.transystems.com)

## MINUTES OF MEETING

Feasibility Study of Proposed Railroad Grade Separation  
Algonquin Road at Union Pacific-Milwaukee Railroad  
City of Des Plaines

### Coordination Meeting #1

Date: June 11, 2008

Time: 11:00 a.m.

Place: City of Des Plaines, Engineering Office, 5<sup>th</sup> Floor

Attendance: Tim Oakley, Director of Engineering  
Jon Duddles, Assistant Director of Engineering  
Derek Peebles, Civil Engineer  
Matt Dusckett, Director of Public Works  
Mike Conlan, Director of Community & Economic Development  
Randy Jaeger, Fire Chief  
Marty Ross, TranSystems  
Ken Yang, TranSystems

The purpose of the meeting was to review and comment the Validation Study 5/15/08 and kick off the feasibility portion of the project. The following are part of the feasibility process; discuss coordination efforts, review scope of the feasibility study, start the data collection process, and review the overall schedule (updated due to the inclusion of the validation study to the project).

#### 1. Validation Study

- a. The validation report was reviewed and the following comments were made:
  - i. Include the existing police station location to the location map (figure 1), not the proposed since the exact location has not been finalized
  - ii. Include the hospital location between Potter Rd. and Greenwood Ave. on Dempster St.
  - iii. TranSystems to update the study and send Derrick the .pdf file for distribution.



Feasibility Study of Proposed Railroad Grade Separation  
Algonquin Road at Union Pacific-Milwaukee Railroad  
Minutes of Meeting  
June 11, 2008  
Page 2

## 2. Coordination, Scope and Goals

- a. Derrick will set up a coordination meeting with adjacent properties; the Park District, UOP, Juno Lighting, and ITW Fastex. The strip mall property owners will not be included in this meeting at this time. This meeting should be held before the survey is started.
- b. Are site distance adequate for adjacent entrances? Will right in- right out be needed for these entrances? The proposed grades will not be severe enough for site distance problems.
- c. UOP had investigated a pedestrian overpass near Mt. Prospect road, this idea is believed to be abandoned, however, the location would have been far enough West out of our project area.
- d. Closing Algonquin road for construction would be an acceptable plan in order to expedite the construction schedule.
- e. Spur tracks are still in operation.
- f. The final feasibility study will be made available to the public and no separate public hearing will be made.
- g. Scope of work will remain per the proposal and contract, looking at the three options Algonquin Rd. under the UPRR, over the UPRR, and raising the UPRR while going under the UPRR.

## 3. Data collection

- a. TranSystems noted that the field survey is schedule to start (7/21/08).
- b. UPRR railroad shots can be obtained by the Des Plains GIS. TranSystems also suggested taking rail shots at each crossing at Thacker St. and Oakton St. in conjunction with the UPRR tables to determine rail grades and elevations.
- c. Existing road plans (IDOT)
- d. Traffic Data, existing and future (Des Plaines and Other)
- e. Public bus routes can be obtained by Pace and School bus routes can be obtained by Septran.
- f. Pedestrian and bike access on bridge should be considered, Derrick will supply the city's bike path plans.
- g. 3 year accident data will be requested by the City (2005, 2006, 2007).
- h. Utility letters for request for information will be sent by TranSystems. (Julie-Design). Also a separate request for the UPRR utilities.
- i. There are no existing drainage problems that the city was aware of on Algonquin Rd.
- j. No changes are anticipated to the existing land usage for the surrounding areas.
- k. TranSystems to check existing GIS received from Des Plaines from noise wall project to see if it includes our project area.
- l. Right-of-way plats to be obtained from IDOT.



Feasibility Study of Proposed Railroad Grade Separation  
Algonquin Road at Union Pacific-Milwaukee Railroad  
Minutes of Meeting  
June 11, 2008  
Page 3

- m. The following should be invited for the 8/29/08 coordination meeting:
  - i. ICC (Brian Vercruysse/.Chuck Broers)
  - ii. IDOT (Chad Riddle/ Steve Mastny)
  - iii. UPRR (John Venice)

Meeting adjourned at 11:45am.

# VALIDATION & FEASIBILITY STUDY REVIEW ATTENDANCE



**City of Des Plaines**

**Engineering Department**

1420 Miner Street

Des Plaines, IL 60016

Tel: 847-391-5390

Fax: 847-391-5619

Project Name: Algonquin Railroad Grade Separation

Date: June 11, 2008

Time: 11:00 A.M.

Place: Engineering Conference Room

<u>Name</u>	<u>Company Name</u>	<u>E-mail Address</u>	<u>Phone Number</u>
Marty Rott	Transystems	marrot@transystems.com	847-605-9600
Derek Peables	DP	dper	
MIKE CONLAN	DP (CEO)		
MATT DUSCKETT	Public Works	mdusket@desplaines.org	847-391-5460
Jon Ruddle	DP		391-6127
Randy Jaeger	Fire	rjaeger@desplaines.org	391-5336
Tim Oakley	DP Engineering	toakley@desplaines.org	391-5390
KEN YANG	TRANSYSTEMS	KKYANG@TRANSYSTEMS.COM	847 467 5278





TranSystems

1051 Perimeter Drive  
Suite 1051  
Schaumburg, IL 60173-5058  
Tel 847.605.9600  
Fax 847.605.9610

[www.transystems.com](http://www.transystems.com)

## MINUTES OF MEETING

Proposed Railroad Grade Separation  
Algonquin Road at Union Pacific-Milwaukee Railroad  
City of Des Plaines  
Park District Building

### Informational Meeting for Adjacent Property Owners

Date: June 27, 2008

Time: 10:00 a.m.

Place: City of Des Plaines Park District, Prairie Lakes Facility

Attendance: Derek Peebles, Civil Engineer, City of Des Plaines  
John Hecker, City of Des Plaines Park District  
Jim Johnsen, Juno Lighting Group  
Ron Robinson, Juno Lighting Group  
Darin Fink, ITW Fastex  
Bill March, ITW Fastex  
Ken Yang, TranSystems  
Ben Vander Wal, TranSystems

The purpose of the meeting was to begin dialogue with the adjacent businesses and give them background on the project. The project schedule and process of design were to be discussed. Also, information from the immediately adjacent business, including questions and concerns, would be received. The following summarizes the discussion.

#### 1. Overview

- a. Project Background/Description, Derek Peebles
  - i. Traffic delay in the City of Des Plaines is a growing problem due to increasing train volumes.
  - ii. There are 32 total at-grade crossings in the City.
  - iii. The City wants to improve traffic congestion by building a grade separation at one of these crossings. All 32 crossings were looked at, and initially, the UP-Milwaukee at Algonquin Rd crossing was determined to be the best option.
  - iv. The City received a grant to perform a Feasibility Study on the viability of a grade separation at this location.



Proposed Railroad Grade Separation  
Algonquin Road at Union Pacific-Milwaukee Railroad  
Minutes of Meeting  
June 27, 2008  
Page 2

- b. Project Validation and Feasibility Study, Ken Yang
  - i. TranSystems was hired by the City to validate the proposed location for grade separation and confirm the focus of a full Feasibility Study. A number of factors were looked at, primarily: construction feasibility due to adjacent land use, emergency response routes, traffic delay (min/veh), traffic volume and potential of residential and commercial relocations.
  - ii. The Validation Study concluded that the crossing at UP-Milwaukee and Algonquin Rd is the most feasible location for the City to build a grade separation.
  - iii. The Feasibility Study (to be completed by November, 2008) will focus in on this one location and determine the most cost effective solution to building a new grade separation between one of the following three options:
    - Roadway Underpass
    - Roadway Overpass
    - Roadway Underpass with Railroad grade changes

## 2. Project Discussion/Concerns/Comments

An open discussion was held to gather information from the adjacent businesses; The City of Des Plaines Park District (NE corner), Juno Lighting Group (SE corner), ITW Fastex (SW corner), and UOP (NW corner). In addition, there were plenty of questions and concerns from the representatives of the adjacent businesses.

- a. Regarding the location, why wasn't Oakton St chosen to grade separate?

Although Oakton St carries more traffic than Algonquin Rd, it is not a feasible location due to the adjacent land use considering how close businesses are to the crossing.
- b. Algonquin Rd will become a four-lane road. Will there be a need for a center turn lane? If there is no center turn lane, there is a concern that traffic will not be able to make left turns onto Algonquin Rd from driveways near the crossing.
- c. If Algonquin Rd between Elmhurst and Mt. Prospect is not widened to four lanes, there is concern that westbound traffic will back up all the way to the east of the railroad and block the driveways east of the tracks (Juno Lighting and The Park District).
- d. What are the degrees of certainty that this is the location to be chosen and that the road will go under the railroad?

The Validation Study confirmed the City's findings that the crossing at UP-Milwaukee and Algonquin Rd is the most feasible location to grade separate. At this point, the City is moving forward with a Feasibility Study focusing on this location. This study will look at which of the three options (shown above) is the most feasible. There is no certainty for one of these options over another at this point.



Proposed Railroad Grade Separation  
Algonquin Road at Union Pacific-Milwaukee Railroad  
Minutes of Meeting  
June 27, 2008  
Page 3

- e. The question was raised on what is to be done with storm water if the road is built to go under the railroad.

All storm water taken within the road's right-of-way will be properly accounted for and taken to the appropriate outfall location. A storm water pump station will likely be necessary in the roadway underpass option.

- f. Derek discussed the general process of most projects and how it relates to this one. The public is usually involved with a Public Hearing during Phase I of a project. At this point, the project is made known to the adjacent land owners. In this project, however, the City is involving the adjacent land owners much sooner in the process, during the Feasibility Study portion of the project.
- g. Will Eminent Domain be something that is likely to occur with the adjacent businesses for this project?

Derek explained that the City is extremely politically sensitive regarding these matters. He does not foresee the need for Eminent Domain and said the City will try to avoid it as much as possible. However, it is too early in the project to determine what property is or is not needed for construction. Algonquin Rd is owned and maintained by IDOT west of Wolf Rd.

- h. How does the pond located on ITW Fastex property impact the reconstruction of Algonquin Rd? The potential pond impacts will be determined in Phase I engineering.
- i. There has been several drainage tiles discovered on the adjacent properties. This need to be taken into consideration during Phase I engineering.
- j. During construction of Juno Lighting's facility, heterogeneous organic material was discovered sporadically about 30' below grade. This should be taken into consideration during the design phases by the geotechnical and structural engineers.
- k. ITW Fastex undergoes changes to their facility about every five years. It is possible that through the duration of this project, their facility may change at least two times.
- l. UOP had plans to construct a pedestrian bridge over Algonquin Rd to serve their campuses on both the north and south side. This plan was the result of several accidents at the pedestrian cross walk on the east side of Algonquin Rd and Mt. Prospect Rd. The status of this project is thought to have died, although representatives from UOP were not present to discuss this plan.
- m. Will property owners incur any cost beyond the cost of the project paid for with grants, public entities, etc.?

Property owners will not pay anything for the project unless they request something "above and beyond" what already exists. For example; the cost of relocating a driveway due to the impacts of lowering Algonquin Rd is a project cost, however, upgrading a driveway type from gravel to concrete is not.



Proposed Railroad Grade Separation  
Algonquin Road at Union Pacific-Milwaukee Railroad  
Minutes of Meeting  
June 27, 2008  
Page 4

- n. Will adjacent businesses need to have all of their questions and concerns submitted to the City by the completion of the Feasibility Study?

No, after the Study, during the Phase I engineering, there is a Public Hearing and a Public Meeting, which are proper settings for the public to voice their questions and concerns regarding the project.

- o. ITW Fastex experiences very low water pressure in their facility. Is it possible to address this problem during this project?

It may be possible to address this problem during the project, in fact, the City is aware of and is looking ahead to fixing some of the low water pressure issues throughout the City.

- p. Regarding the constructability of the bridge; how will train traffic be maintained while constructing a bridge?

To construct the bridge while maintaining train traffic, a shoofly track will need to be built. This is a temporary track that runs around the existing crossing while the proposed structure is built.

- q. Are there other communities in the area going through similar projects to grade separate any existing at-grade crossings?

Grand Avenue in Franklin Park was completed late 2007. This project is a roadway/railroad grade separation. Grand Avenue is part of The Chicago Region Environmental and Transportation Efficiency Program (CREATE). CREATE is a \$1.5 billion program geared to reduce rail and motorist congestion in the Chicago Region by creating, among others, grade separations at congested crossings.

- r. Is the UP-Milwaukee line a main artery for the Union Pacific?

Yes, it is the main line artery running from the UP's Proviso Yard north to Milwaukee.

Meeting adjourned at 10:45am

ATTENDANCE - ADJACENT PROPERTY OWNERS INFORMATIONAL MTG.  
JUNE 27, 2008 - PRAIRIE LAKES

NAME	COMPANY	EMAIL	PHONE
Derek Peebles	Des Plaines	dpeebles@desplaines.org	847-391-5389
JOHN HECKER	PARK DIST	jha@desplainesparks.org	847-391-5700
JIM JOHNSEN	JUNO	JJOHNSEN@JUNOLTG.COM	847-813-8539
Red ROBINSON	JUNO	RROBINSON@JUNOLTG.COM	847-813-8548
PAIRIN FINK	ITW FASTEX	DFINK@ITWFASTEX.COM	847-803-7733
Bill March	ITW Fastex	bmail@itwfastex.com	847-833-6275 (cell)
KENNETH YANG	TRANSYSTEMS	KKYANG@TRANSYSTEMS.COM	847-407-5278
BEN VANDER WA	TS	bvanderwal@transystems.com	847-407-5240



TranSystems

1051 Perimeter Drive  
Suite 1051  
Schaumburg, IL 60173-5058  
Tel 847.605.9600  
Fax 847.605.9610

[www.transystems.com](http://www.transystems.com)

FINAL

MINUTES OF MEETING

Feasibility Study of Proposed Railroad Grade Separation  
Algonquin Road at Union Pacific-Milwaukee Railroad  
City of Des Plaines

Coordination Meeting #2  
Design Evaluation Alternative

Date: September 12, 2008  
Time: 10:30 a.m.  
Place: City of Des Plaines, Engineering Office, 5<sup>th</sup> Floor  
Attendance: See attendance roster (attached)

The purpose of the meeting was to present and review the design evaluation alternatives for the feasibility portion of the project.

1. Project Overview: TranSystems provided a brief introduction of the history of the project to date. The City has 32 at-grade railroad crossings impeding traffic and delaying emergency response time. An internal study was done by the City to determine which crossing location was the most feasibly to grade separate. Algonquin Road and the Union Pacific Railroad–Milwaukee line (UPRR) was determined to be the most feasible location and TranSystems was contracted to complete the feasibility study. However prior to the feasibility study, a validation study report was conducted by TranSystems to validate the City's findings. The study concurred with the City's findings.

A description of the existing conditions and the land use along Algonquin Road and the surrounding area within the project limits was provided. (The project limits are Mt. Prospect Road on the west to Wolf Road on the east)

- Industrial company: UOP/Honeywell on the northwest and southwest quadrants of the crossing.
- Industrial company: ITW Fastex in the direct southwest quadrant of the crossing.
- Industrial company: Juno lighting on the southeast quadrant of the crossing.



Feasibility Study of Proposed Railroad Grade Separation  
Algonquin Road at Union Pacific-Milwaukee Railroad  
FINAL Minutes of Meeting  
September 12, 2008  
Page 2

- The Des Plaines Park District (Mountain View Adventure Center) on the northeast quadrant of the crossing.
- Commercial/Retail on the northeast quadrant of the crossing.
- Existing Algonquin Road is two lanes in either direction on the west at Mt. Prospect Road and on the east at Wolf Road, with channelized left turn lanes. At the crossing with the UPRR the road narrows to one lane in each direction.
- Algonquin Road is designated as a collector. It has a posted speed limit of 35 mph, and a design speed of 40 mph.

Existing utilities along Algonquin Road:

- A 48" storm sewer runs on the south side outside edge of pavement west of UPRR to inside edge of pavement East of UPRR. The existing roadway drainage pattern shows that water is collected along Algonquin Road and drains to this 48" pipe which eventually outfalls to the east at the Des Plaines River.
- A 10" water main runs along the north side edge of pavement. An 18" sanitary sewer runs along the north side edge of pavement.
- A gas line is located between the 18" sanitary sewer and the 10" water main.
- Overhead ComEd and underground AT&T cables are located outside the edge of pavement on the south side of Algonquin Road.
- The existing utility along the east side of the UPRR is ComEd.
- Underground Level (3), overhead UPRR communication, and a water main exist on the west side of the UPRR.

## 2. Alternate Review and Impacts

TranSystems presented three alternates: Algonquin Road over the UPRR, Algonquin Road under the UPRR and a combination of Algonquin Road under the UPRR and a raise of the UPRR.

Alternate 1: Algonquin Road Overpass with retaining wall or with side slopes and minimal use of retaining wall.

- The proposed roadway and bridge typical sections were displayed; in addition past the point of vertical tie-in, widening is provided for the additional 12 ft lanes and 12 ft flushed median (Existing: 16 ft at Mt. Prospect and Wolf Roads). At the bridge, the flushed median is reduced from 12 ft to 4 ft. Curb and gutter with no street parking and a center left turn lane are continuous throughout the improvement.
- Limits of reconstruction and widening, and resurfacing were noted.



Feasibility Study of Proposed Railroad Grade Separation  
Algonquin Road at Union Pacific-Milwaukee Railroad  
FINAL Minutes of Meeting  
September 12, 2008  
Page 3

- A 10 ft multi-use/shared bike path is accommodated on the north side. However, a discrepancy was noted regarding a bike path route along Algonquin Road was in the long range plan between the Chicagoland Bicycle Federation map and the CMAQ maps vs. the City's comprehensive plan conducted in 2007. It was stated by the City that Algonquin Road should be designate for an off road bike path.
- The profile uses 5% grades with a clearance of 23 ft - 6 in over the UPRR. It was noted that the minimum required clearance is 23 ft. The additional 6 in are provided for the future resurfacing of the UPRR tracks.
- The bridge is a 3-span (90 ft – 120 ft – 90 ft; 300 ft total in length) deck bridge that uses 6 ft deep concrete beams.
- The bridge piers are located outside the existing UPRR right-of-way, which gives the UPRR the freedom for future track expansion under the bridge.
- Retaining walls were shown which minimize the project footprint. However, proposed right-of-way was also shown and discussed for the condition of a 10 ft clear zone and 2:1 side slopes in lieu of the retaining wall. In either case there are certain areas that retaining wall would be necessary to avoid wetland impacts and impacts to the Park District miniature golf course and its ponds.

Impacts to each commercial property, including driveway impacts, were discussed for both a retaining wall section and a 10 ft clear zone with a 2:1 side slope section.

- Entrance closures and adjustments to UOP.
- ITW Fastex driveway would require relocation. Driveway was designed for a WB-65 design vehicle. The city suggested that the driveway position will need to be discussed with ITW. They will likely want the driveway near the existing building or near Algonquin road to keep their property open for future building expansions.
- Juno Lighting will require driveway relocation and parking mitigation. (approximately 20 spaces for the retaining wall section and 40 spaces for the side slope condition)
- The Park District would require a raise at its entrance, a 2% storage area for 150 ft to a 5% grade to existing is provided.
- The Park District would have 15 ft high retaining walls and would require some vertical adjustments to the existing surrounding walk/bike path.
- No flood plain or floodway impacts.
- No wetland impacts.





Feasibility Study of Proposed Railroad Grade Separation  
Algonquin Road at Union Pacific-Milwaukee Railroad  
FINAL Minutes of Meeting  
September 12, 2008  
Page 4

- The construction cost of this alternate is \$17 million with retaining walls to \$20 million with minimized retaining walls. Including Right-of-Way agreements, private utility relocations, design and construction engineering, the total cost ranges from \$24 million to \$26 million.

Alternate 2: Algonquin Road Underpass with retaining wall or side slopes with minimal retaining wall.

- Proposed roadway and bridge typical sections were displayed; in addition past the point of vertical tie-in, widening is provided for the additional 12 ft lanes and 12 ft flushed median (Existing: 16 ft at Mt. Prospect and Wolf roads). Curb and gutter with no street parking and a center left turn lane are continuous throughout the improvement.
- Limits of reconstruction and widening and resurfacing were noted.
- The same multi-use paths for pedestrian and bicycles were noted.
- The profile uses 5% grades with a clearance of 14 ft - 9 in under the UPRR. It was discussed why the low point of the profile was placed 100 ft west of the edge of the proposed structure. It is for the purposes of keeping the low point out of the shadow of the bridge for icing and keep any potential ponding out from directly under the structure.
- The bridge is an 81 ft through plate girder single span bridge. However, a deck girder bridge would be preferred by the UPRR; it would require a 4 ft deeper bridge depth and profile which could be explored further in the Phase 1 process.
- The bridge carries the 12ft bi-directional turn lane under the bridge.
- This option showed a need for a pump station. Locations of the pump station and drainage detention, due to the increase impervious cover with the additional lanes, were discussed.
- This option would require a shoofly of the UPRR mainline tracks in order to build the underpass bridge. This would require additional temporary easements and earth retention to avoid impacts to adjacent wetlands or mitigate wetlands through banking if less expensive.

Impacts to each commercial property including driveway impacts were discussed for both a retaining wall section and a 10 ft clear zone with a 2:1 side slope section, which were much less than Alternate 1:

- Entrance closures and adjustments to UOP.
- ITW Fastex driveway would require relocation.
- Juno Lighting would only require small vertical adjustments to the entrance and no parking mitigation.
- The Park District would only require small vertical adjustments to their entrance.



- The construction cost of this alternate is \$20 million with retaining walls to \$22 million with minimized retaining walls. Including Right-of-Way agreements, private utility relocations, design and construction engineering, the total cost ranges from \$26 million to \$28 million.

#### Alternate 3: Algonquin Underpass with UPRR Track Raise

- The original thought of this option was to avoid the need for a pump station for Algonquin Road under the UPRR, if the track could be raised less than 2 ft to avoid major railroad construction.
- However based on the research and preliminary design the UPRR would need to be raised 11 ft in order to avoid the need for a pump station. Furthermore, additional drainage design would need to be done to tie back into the existing 48" storm sewer.
- The UPRR mainline tracks would need a split shoofly both to the north and south of the existing track in order to construct the new tracks and avoid impacts to adjacent residential and commercial properties.
- This option would require extensive UPRR coordination and major construction of both the UPRR and Algonquin Road, which would increase the overall costs over the first two options by over 50%. Construction cost of \$36 million and total costs including right-of-way agreements, private utility relocations, design and construction engineering of \$45 million.
- It was clear that this option was not feasible and will be dismissed in the feasibility study.

#### 3. Staging Concepts

- In all options closing Algonquin Road for the duration of construction, while still maintaining local access, was the best option to reduce the total duration of the project. This idea was discussed and agreed to at the June 11th coordination meeting.
- Detour routes around Algonquin Road were shown and it was reasonable and feasible to close Algonquin Road during construction.
- Alternate 2 would require much more coordination with the UPRR than Alternate 1.

#### 4. Preliminary Costs

- Preliminary costs were provided for all three alternates, including the difference between retaining wall and the minimal retaining wall options.
- It was suggested that right-of-way acquisition unit cost be \$25/sf instead of \$20/sf.
- Also the temporary easement quantity should be verified it appears to be low for Alternate 2, does it include shoofly easements? Also the cost for easements from the Park District should be included. The locations of these easements should be shown on the plans.



Feasibility Study of Proposed Railroad Grade Separation  
Algonquin Road at Union Pacific-Milwaukee Railroad  
FINAL Minutes of Meeting  
September 12, 2008  
Page 6

- It was noted that there was no cost for any improvement of the existing 48" storm sewer, it was assumed to be working adequately to convey the roadway drainage to the ultimate outfall.
- Potential savings could be realized by using a narrowed bridge section that could accommodate a future widening to 11 ft through lanes instead of 12 ft lanes presented. The city was not in favor of a narrowing the roadway cross section significantly across the bridge, it is preferred to build some flexibility due to the this project being a one time opportunity.
- It was asked what the life span of the structures is: 100 years with redecking every 25 years as needed.

5. Schedule

- Attached was the schedule for the draft feasibility study, subsequent meeting and final report.

6. Open Discussion

- We should be sensitive/aware/gauge public response to the project. The grade separation may cause traffic from other east-west roadways and divert to Algonquin Road, increasing traffic volumes.
- IDOT's preference to a Jurisdictional transfer (JT) to the City of Des Plaines would have a western limit at IL 83. These talks could start at any time during the process. It would be up to the City to decide when to pursue the JT with IDOT.
- Typically, the ownership of the structure over the UPRR would be the City's. However for the underpass option, ownership of the superstructure would be the UPRR and the substructure the City.
- Multiple funding sources would be necessary for this project; possible funding programs include STP funds through the Northwest Municipal Conference, CMAQ for "Bottleneck Elimination" and bike path improvements, and ITEP for bike path and some aesthetic improvements. In addition, funding can be sought from IDOT and the UPRR. These funding sources will be explored as part of the feasibility study and the Phase I study.

Meeting adjourned at 11:50 am



ATTENDANCE ROSTER

Project: Algonquin Rd./UP Feasibility Study
Limits: Mt. Prospect Rd. to Wolf Rd.
Topic: Alternatives Review Mtg.

Date: 9-12-08
Time: 10:30 AM
Location: City of Des Plaines Engr. Dept.

Table with 3 columns: Name, Representing, Email. Rows include: Derek Peebles (Des Plaines, dpeebles@desplaines.org), Jon Budder (D.P., Jbudder@desplaines.org), Tim Oakley (Des Plaines, toakley@desplaines.org), Steve Mastroy (IDOT, steve.mastroy@illinois.gov), Mally Boss (TranSystems, mally@transystems.com), KEN YANG (TRANSYSTEMS, KYANG@TRANSYSTEMS.COM), Grace Dysico (TranSystems, gldysico@transystems.com).



TranSystems

1051 Perimeter Drive  
Suite 1051  
Schaumburg, IL 60173-5058  
Tel 847.605.9600  
Fax 847.605.9610

[www.transystems.com](http://www.transystems.com)

## MINUTES OF MEETING

Feasibility Study of Proposed Railroad Grade Separation  
Algonquin Road at Union Pacific-Milwaukee Railroad  
City of Des Plaines

### Initial Project Meeting

Date: October 21, 2008  
Time: 11:15 a.m.  
Place: City of Chicago, O'hare modernization Program offices.  
Attendance: John Venice, Union Pacific Railroad  
Rich Ellison, Union Pacific Railroad  
Ken Yang, TranSystems

The purpose of the meeting was to review the draft study of the project and gather input from the Union Pacific Railroad (UPRR) regarding the alternates and possible impacts.

1. Project Overview: TranSystems provided a brief introduction of the history of the project to date. The UPRR has history with the project and had a base knowledge of the project. The City has 32 at-grade railroad crossings impeding traffic and delaying emergency response time. Algonquin Road and the Union Pacific Railroad–Milwaukee line (UPRR) was determined to be the most feasible location and TranSystems was contracted to complete the feasibility study.

#### 2. Alternate Review and Impacts

TranSystems presented three alternates: Algonquin Road over the UPRR, Algonquin Road under the UPRR and a combination of Algonquin Road under the UPRR and a raise of the UPRR.

Alternate 1: Algonquin Road Overpass with retaining wall or with side slopes and minimal use of retaining wall.

- The profile uses 5% grades with a clearance of 23 ft - 6 in over the UPRR. It was noted that the minimum required clearance is 23 ft. The additional 6 in are provided for the future resurfacing of the UPRR tracks.
- The bridge is a 3-span (90 ft – 120 ft – 90 ft; 300 ft total in length) deck bridge that uses 6 ft deep concrete beams.
- The bridge piers are located outside the existing UPRR right-of-way, which gives the UPRR the freedom for future track expansion under the bridge.



Feasibility Study of Proposed Railroad Grade Separation  
Algonquin Road at Union Pacific-Milwaukee Railroad  
Minutes of Meeting  
October 21, 2008  
Page 2

- The UPRR was pleased to see that the bridge openings span the width of the existing UPRR right-of-way. It was stated that this proposed bridge layout would go through the UPRR review process with little objections.
- Retaining walls were shown which minimize the project footprint. However, proposed right-of-way was also shown and discussed for the condition of a 10 ft clear zone and 2:1 side slopes in lieu of the retaining wall. In either case there are certain areas that retaining wall would be necessary to avoid wetland impacts and impacts to the Park District miniature golf course and its ponds.
- TranSystems pointed out that there is a service road northwest quadrant of the Algonquin road crossing, but not on the southwest quadrant. The UPRR indicated that this service road was actually an abandoned third track line. The UPRR did not need a proposed access road in this project area.
- This option was the most desirable to the UPRR and recommended. The UPRR made it quite clear that Algonquin over the UPRR option was the best for them. This option would have the least impacts to the UPRR, go through the UPRR design approval process with no issues, and perceived least amount of costs to the City and UPRR.
- The UPRR would participate up to 5% of the bridge construction cost (touchdown to touchdown) for eliminating an at-grade crossing.

Alternate 2: Algonquin Road Underpass with retaining wall or side slopes with minimal retaining wall.

- The profile uses 5% grades with a clearance of 14 ft - 9 in under the UPRR.
- The bridge is an 81 ft through plate girder single span bridge. However, a deck girder bridge would be preferred by the UPRR; it would require a 4 ft deeper bridge depth and profile which could be explored further in the Phase 1 process.
- This option showed a need for a pump station. Locations of the pump station and drainage detention, due to the increase impervious cover with the additional lanes, were discussed.
- This option would require a shoofly of the UPRR mainline tracks in order to build the underpass bridge. This would require additional temporary easements and earth retention to avoid impacts to adjacent wetlands or mitigate wetlands through banking if less expensive.
- The UPRR stated that the shoofly must be designed for time table speed of 40 mph.
- For the shoofly, the existing utility along the east side of the UPRR is ComEd. Underground Level (3), overhead UPRR communication, and a water main exist on the west side of the UPRR.
- The UPRR did not like this option. It would have more impacts to their operations with potential complications with the shoofly and spurs.



Feasibility Study of Proposed Railroad Grade Separation  
Algonquin Road at Union Pacific-Milwaukee Railroad  
Minutes of Meeting  
October 21, 2008  
Page 3

- It was noted that the signalized crossings would need to be in place over the shoofly during construction. And in general, no signalized crossings would be allowed to be removed until the bridges/roadway is constructed/operational and no potential traffic local or construction would use the crossing.

#### Alternate 3: Algonquin Underpass with UPRR Track Raise

- The original thought of this option was to avoid the need for a pump station for Algonquin Road under the UPRR, if the track could be raised less than 2 ft to avoid major railroad construction.
- However based on the research and preliminary design the UPRR would need to be raised 11 ft in order to avoid the need for a pump station. Furthermore, additional drainage design would need to be done to tie back into the existing 48" storm sewer.
- The UPRR mainline tracks would need a split shoofly both to the north and south of the existing track in order to construct the new tracks and avoid impacts to adjacent residential and commercial properties.
- This option would require extensive UPRR coordination and major construction of both the UPRR and Algonquin Road, which would increase the overall costs over the first two options by over 50%. Construction cost of \$36 million and total costs including right-of-way agreements, private utility relocations, design and construction engineering of \$45 million.
- It was clear that this option was not feasible and will be dismissed in the feasibility study.
- The UPRR agreed that this alternate should not be considered.

#### 3. Staging Concepts

- In all options closing Algonquin Road for the duration of construction, while still maintaining local access, was the best option to reduce the total duration of the project. This idea was discussed and agreed to at the June 11th coordination meeting with the City of Des Plaines.
- Alternate 2 would require much more coordination with the UPRR than Alternate 1.

#### 4. Next Steps

A meeting to review the draft feasibility study is scheduled for the end of October/ beginning of November to obtain comments from the City of Des Plaines. The final recommended alternate and feasibility study is scheduled to be submitted at the end of November.

The meeting adjourned at 11:45 a.m.





UTILITY  
CORRESPONDENCE



FAXCFM 00002 JULIEa 06/23/08 09:17:12 A1750736-00A DESIGN GRID

Dig No : A1750736 Priority: 2 Digstart: 12/23/08 Time: 09:05  
 Rcvd : 06/23/08 09:04 Operator: KXS Rev : 00A  
 Org Dig: A1750736 Rcvd: 06/23/08 09:04 Oper: KXS  
 County : COOK Place : DES PLAINES CIT  
 Address: Street : E ALGONQUIN RD  
 Cross : WOLF RD Subdivision:  
 Locat : IN THE CITY OF DES PLAINES,  
 :  
 :

Type : DESIGN STAGE-INSTALL NEW BRIDGE  
 Extent : WORK BEING DONE ON E ALGONQUIN RD ONLY  
 DoneFor: CITY OF DES PLAINES  
 :

Firm : TRANSYSTEMS CO. Caller: BEN VANDERWALL  
 Address: 1051 PERIMETER DR SUITE 1025  
 City, St: SCHAUMBURG, IL Zip : 60173  
 Phone : 847-407-5240 Ext : Fax: 847-605-9610  
 Call Bk:  
 SiteCnt: SAME  
 :

Grids : T41NR12E19\*E  
 :

Remarks: Planning purpose message only. Retain for potential future locate.  
 : DIRECTIONAL BORING=YES. DEPTH EXCEEDS 7 FEET=YES.  
 : TICKET EXPIRES AFTER 01/01/00

## Members:

ATTOA	ATT / T (TRANSMISSION) (ORI	CARL DONAHUE	847-420-9116
ATT51A	ATT/DISTRIBUTION (USED TO BE	SHARON TILJAK	708-709-2523
CEC00A	COM ED	TOM STUTZMAN	630-437-2236
CLS0A	CENTRAL LOCATING SERVICE	Information not provided	
CDM4A	COMCAST	MARTHA GIERAS	630-600-6352
DPLN0A	DES PLAINES, CITY OF	TIM DAKLEY	847-391-5390
LEVLOA	LEVEL 3 COMMUNICATIONS	MARSHA KIDD	918-547-0029
MCIOA	MCI	DEAN BOYERS	972-729-6322
MWRDOA	METROPOLITAN WTR REC DIST CHI	DR. AMREEK PAINTAL	312-751-4020
NEXT0A	XO ILLINOIS INC	GLENN LUEHRSEN	630-371-3108
NICR2A	NICOR GAS	UTILITY CONSULTANT G03W	630-388-2362
SMP3A	SMP CONT LOCATOR-ROCKFORD/CHE	Information not provided	
TCGCOA	ATT / T-TCG (USED TO BE ATT/L	LLOYD MAGOWN	903-753-3145

September 12, 2008

Mr. Carl Donahue  
OSPEC Engineer  
866 Rock Creek Road  
Plano, IL. 60545Reference: Algonquin Road Grade Separation Preliminary Design Study  
Illinois Route 62 (Mount Prospect Road to Wolf Road)  
Cook County

Dear Mr. Donahue:

On behalf of the City of Des Plaines, TranSystems has initiated the preliminary design studies for the referenced project. To assist us in this project, we would appreciate you providing us with any available information as to the locations of your existing and proposed facilities adjacent to or within the study limits. The study limits extend along Algonquin Road between Mount Prospect Road and Wolf Road and along Union Pacific Railroad Milwaukee Subdivision 2,600 feet north and south of Algonquin Road. A project location map is enclosed for your reference.

The proposed improvements under study consist of:

- Roadway widening.
- Construction of the bridge over or under the UPRR.
- Profile modification along Algonquin Road.
- Construction of retaining walls.
- Sewer and water main replacement.

Please provide existing utility atlases for the project area and plans for any future work. Please provide the requested information by November 7, 2008 or provide a response letter if you do not have any facilities within the study limits.

Thank you for your assistance in this matter. If you have any questions or require additional information, please call me at (847) 407-5262 or e-mail me at [mlbeening@transystems.com](mailto:mlbeening@transystems.com).

Very truly yours,

TranSystems



Michael L. Beening

Enclosures

cc: Derek Peebles, P.E. - City of Des Plaines



September 12, 2008

Ms. Sharon Tiljak  
AT&T Illinois  
40 South Mitchell Court  
Addison, IL. 60101

**TranSystems**

1051 Perimeter Drive  
Suite 1025  
Schaumburg, IL 60173  
Tel 847-605-9600  
Fax 847-605-9610

[www.transystems.com](http://www.transystems.com)

Reference: Algonquin Road Grade Separation Preliminary Design Study  
Illinois Route 62 (Mount Prospect Road to Wolf Road)  
Cook County

Dear Ms. Tiljak:

On behalf of the City of Des Plaines, TranSystems has initiated the preliminary design studies for the referenced project. To assist us in this project, we would appreciate you providing us with any available information as to the locations of your existing and proposed facilities adjacent to or within the study limits. The study limits extend along Algonquin Road between Mount Prospect Road and Wolf Road and along Union Pacific Railroad Milwaukee Subdivision 2,600 feet north and south of Algonquin Road. A project location map is enclosed for your reference.

The proposed improvements under study consist of:

- Roadway widening.
- Construction of the bridge over or under the UPRR.
- Profile modification along Algonquin Road.
- Construction of retaining walls.
- Sewer and water main replacement.

Please provide existing utility atlases for the project area and plans for any future work. Please provide the requested information by November 7, 2008 or provide a response letter if you do not have any facilities within the study limits.

Thank you for your assistance in this matter. If you have any questions or require additional information, please call me at (847) 407-5262 or e-mail me at [mlbeening@transystems.com](mailto:mlbeening@transystems.com).

Very truly yours,

TranSystems



Michael L. Beening

Enclosures

cc: Derek Peebles, P.E. - City of Des Plaines



**TranSystems**

1051 Perimeter Drive  
Suite 1025  
Schaumburg, IL 60173  
Tel 847-605-9600  
Fax 847-605-9610

[www.transystems.com](http://www.transystems.com)

September 12, 2008

Mr. Tom Stutzman  
Commonwealth Edison Company  
Three Lincoln Centre  
Oakbrook Terrace, IL. 60181-4260

Reference: Algonquin Road Grade Separation Preliminary Design Study  
Illinois Route 62 (Mount Prospect Road to Wolf Road)  
Cook County

Dear Mr. Stutzman:

On behalf of the City of Des Plaines, TranSystems has initiated the preliminary design studies for the referenced project. To assist us in this project, we would appreciate you providing us with any available information as to the locations of your existing and proposed facilities adjacent to or within the study limits. The study limits extend along Algonquin Road between Mount Prospect Road and Wolf Road and along Union Pacific Railroad Milwaukee Subdivision 2,600 feet north and south of Algonquin Road. A project location map is enclosed for your reference.

The proposed improvements under study consist of:

- Roadway widening.
- Construction of the bridge over or under the UPRR.
- Profile modification along Algonquin Road.
- Construction of retaining walls.
- Sewer and water main replacement.

Please provide existing utility atlases for the project area and plans for any future work. Please provide the requested information by November 7, 2008 or provide a response letter if you do not have any facilities within the study limits.

Thank you for your assistance in this matter. If you have any questions or require additional information, please call me at (847) 407-5262 or e-mail me at [mlbeening@transystems.com](mailto:mlbeening@transystems.com).

Very truly yours,

TranSystems



Michael L. Beening

Enclosures

cc: Derek Peebles, P.E. - City of Des Plaines



September 12, 2008

Ms. Martha Gieras  
Comcast Cable  
688 Industrial Drive  
Elmhurst, IL. 60126

**TranSystems**

1051 Perimeter Drive  
Suite 1025  
Schaumburg, IL 60173  
Tel 847-605-9600  
Fax 847-605-9610

[www.transystems.com](http://www.transystems.com)

Reference: Algonquin Road Grade Separation Preliminary Design Study  
Illinois Route 62 (Mount Prospect Road to Wolf Road)  
Cook County

Dear Ms. Gieras:

On behalf of the City of Des Plaines, TranSystems has initiated the preliminary design studies for the referenced project. To assist us in this project, we would appreciate you providing us with any available information as to the locations of your existing and proposed facilities adjacent to or within the study limits. The study limits extend along Algonquin Road between Mount Prospect Road and Wolf Road and along Union Pacific Railroad Milwaukee Subdivision 2,600 feet north and south of Algonquin Road. A project location map is enclosed for your reference.

The proposed improvements under study consist of:

- Roadway widening.
- Construction of the bridge over or under the UPRR.
- Profile modification along Algonquin Road.
- Construction of retaining walls.
- Sewer and water main replacement.

Please provide existing utility atlases for the project area and plans for any future work. Please provide the requested information by November 7, 2008 or provide a response letter if you do not have any facilities within the study limits.

Thank you for your assistance in this matter. If you have any questions or require additional information, please call me at (847) 407-5262 or e-mail me at [mlbeening@transystems.com](mailto:mlbeening@transystems.com).

Very truly yours,

TranSystems



Michael L. Beening

Enclosures

cc: Derek Peebles, P.E. - City of Des Plaines



September 12, 2008

Ms. Marsha Kidd  
Level 3- Network Relocations Department  
100 S. Cincinnati Ave  
Tulsa, OK. 74103

**TranSystems**

1051 Perimeter Drive  
Suite 1025  
Schaumburg, IL 60173  
Tel 847-605-9600  
Fax 847-605-9610

[www.transystems.com](http://www.transystems.com)

Reference: Algonquin Road Grade Separation Preliminary Design Study  
Illinois Route 62 (Mount Prospect Road to Wolf Road)  
Cook County

Dear Ms. Kidd:

On behalf of the City of Des Plaines, TranSystems has initiated the preliminary design studies for the referenced project. To assist us in this project, we would appreciate you providing us with any available information as to the locations of your existing and proposed facilities adjacent to or within the study limits. The study limits extend along Algonquin Road between Mount Prospect Road and Wolf Road and along Union Pacific Railroad Milwaukee Subdivision 2,600 feet north and south of Algonquin Road. A project location map is enclosed for your reference.

The proposed improvements under study consist of:

- Roadway widening.
- Construction of the bridge over or under the UPRR.
- Profile modification along Algonquin Road.
- Construction of retaining walls.
- Sewer and water main replacement.

Please provide existing utility atlases for the project area and plans for any future work. Please provide the requested information by November 7, 2008 or provide a response letter if you do not have any facilities within the study limits.

Thank you for your assistance in this matter. If you have any questions or require additional information, please call me at (847) 407-5262 or e-mail me at [mlbeening@transystems.com](mailto:mlbeening@transystems.com).

Very truly yours,

TranSystems



Michael L. Beening

Enclosures

cc: Derek Peebles, P.E. - City of Des Plaines





September 12, 2008

Mr. Kris Kalicki  
MCI  
7719 W. 60<sup>th</sup> Place  
Summit, IL. 60501

**TranSystems**

1051 Perimeter Drive  
Suite 1025  
Schaumburg, IL 60173  
Tel 847-605-9600  
Fax 847-605-9610

[www.transystems.com](http://www.transystems.com)

Reference: Algonquin Road Grade Separation Preliminary Design Study  
Illinois Route 62 (Mount Prospect Road to Wolf Road)  
Cook County

Dear Mr. Kalicki:

On behalf of the City of Des Plaines, TranSystems has initiated the preliminary design studies for the referenced project. To assist us in this project, we would appreciate you providing us with any available information as to the locations of your existing and proposed facilities adjacent to or within the study limits. The study limits extend along Algonquin Road between Mount Prospect Road and Wolf Road and along Union Pacific Railroad Milwaukee Subdivision 2,600 feet north and south of Algonquin Road. A project location map is enclosed for your reference.

The proposed improvements under study consist of:

- Roadway widening.
- Construction of the bridge over or under the UPRR.
- Profile modification along Algonquin Road.
- Construction of retaining walls.
- Sewer and water main replacement.

Please provide existing utility atlases for the project area and plans for any future work. Please provide the requested information by November 7, 2008 or provide a response letter if you do not have any facilities within the study limits.

Thank you for your assistance in this matter. If you have any questions or require additional information, please call me at (847) 407-5262 or e-mail me at [mlbeening@transystems.com](mailto:mlbeening@transystems.com).

Very truly yours,

TranSystems

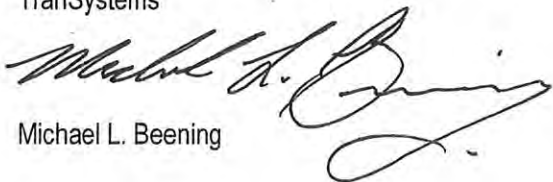

Michael L. Beening

Enclosures

cc: Derek Peebles, P.E. - City of Des Plaines



September 12, 2008

Dr. Amreek Paintal  
Supervising Civil Engineer  
MWRD  
100 E. Erie Street  
Chicago, IL. 60611

**TranSystems**

1051 Perimeter Drive  
Suite 1025  
Schaumburg, IL 60173  
Tel 847-605-9600  
Fax 847-605-9610

www.transystems.com

Reference: Algonquin Road Grade Separation Preliminary Design Study  
Illinois Route 62 (Mount Prospect Road to Wolf Road)  
Cook County

Dear Dr. Paintal:

On behalf of the City of Des Plaines, TranSystems has initiated the preliminary design studies for the referenced project. To assist us in this project, we would appreciate you providing us with any available information as to the locations of your existing and proposed facilities adjacent to or within the study limits. The study limits extend along Algonquin Road between Mount Prospect Road and Wolf Road and along Union Pacific Railroad Milwaukee Subdivision 2,600 feet north and south of Algonquin Road. A project location map is enclosed for your reference.

The proposed improvements under study consist of:

- Roadway widening.
- Construction of the bridge over or under the UPRR.
- Profile modification along Algonquin Road.
- Construction of retaining walls.
- Sewer and water main replacement.

Please provide existing utility atlases for the project area and plans for any future work. Please provide the requested information by November 7, 2008 or provide a response letter if you do not have any facilities within the study limits.

Thank you for your assistance in this matter. If you have any questions or require additional information, please call me at (847) 407-5262 or e-mail me at mlbeening@transystems.com.

Very truly yours,

TranSystems



Michael L. Beening

Enclosures

cc: Derek Peebles, P.E. - City of Des Plaines



September 12, 2008

Mr. Glenn Luehrsen  
XO Communications  
810 Jorie Blvd, Suite 200  
Oakbrook IL. 60523

**TranSystems**

1051 Perimeter Drive  
Suite 1025  
Schaumburg, IL 60173  
Tel 847-605-9600  
Fax 847-605-9610

[www.transystems.com](http://www.transystems.com)

Reference: Algonquin Road Grade Separation Preliminary Design Study  
Illinois Route 62 (Mount Prospect Road to Wolf Road)  
Cook County

Dear Mr. Luehrsen:

On behalf of the City of Des Plaines, TranSystems has initiated the preliminary design studies for the referenced project. To assist us in this project, we would appreciate you providing us with any available information as to the locations of your existing and proposed facilities adjacent to or within the study limits. The study limits extend along Algonquin Road between Mount Prospect Road and Wolf Road and along Union Pacific Railroad Milwaukee Subdivision 2,600 feet north and south of Algonquin Road. A project location map is enclosed for your reference.

The proposed improvements under study consist of:

- Roadway widening.
- Construction of the bridge over or under the UPRR.
- Profile modification along Algonquin Road.
- Construction of retaining walls.
- Sewer and water main replacement.

Please provide existing utility atlases for the project area and plans for any future work. Please provide the requested information by November 7, 2008 or provide a response letter if you do not have any facilities within the study limits.

Thank you for your assistance in this matter. If you have any questions or require additional information, please call me at (847) 407-5262 or e-mail me at [mlbeening@transystems.com](mailto:mlbeening@transystems.com).

Very truly yours,

TranSystems



Michael L. Beening

Enclosures

cc: Derek Peebles, P.E. - City of Des Plaine



September 12, 2008

Ms. Constance Lane  
Utility Consultant  
Nicor Gas  
1844 Ferry Road  
Naperville, IL. 60563-9600

**TranSystems**

1051 Perimeter Drive  
Suite 1025  
Schaumburg, IL 60173  
Tel 847-605-9600  
Fax 847-605-9610

[www.transystems.com](http://www.transystems.com)

Reference: Algonquin Road Grade Separation Preliminary Design Study  
Illinois Route 62 (Mount Prospect Road to Wolf Road)  
Cook County

Dear Ms. Lane:

On behalf of the City of Des Plaines, TranSystems has initiated the preliminary design studies for the referenced project. To assist us in this project, we would appreciate you providing us with any available information as to the locations of your existing and proposed facilities adjacent to or within the study limits. The study limits extend along Algonquin Road between Mount Prospect Road and Wolf Road and along Union Pacific Railroad Milwaukee Subdivision 2,600 feet north and south of Algonquin Road. A project location map is enclosed for your reference.

The proposed improvements under study consist of:

- Roadway widening.
- Construction of the bridge over or under the UPRR.
- Profile modification along Algonquin Road.
- Construction of retaining walls.
- Sewer and water main replacement.

Please provide existing utility atlases for the project area and plans for any future work. Please provide the requested information by November 7, 2008 or provide a response letter if you do not have any facilities within the study limits.

Thank you for your assistance in this matter. If you have any questions or require additional information, please call me at (847) 407-5262 or e-mail me at [mlbeening@transystems.com](mailto:mlbeening@transystems.com).

Very truly yours,

TranSystems

Michael L. Beening

Enclosures

cc: Derek Peebles, P.E. - City of Des Plaines



September 12, 2008

Mr. Jim Evertte  
AT&T / T-TCG  
300 N. Point Parkway  
Alpharetta, Ga. 30005-4116

**TranSystems**

1051 Perimeter Drive  
Suite 1025  
Schaumburg, IL 60173  
Tel 847-605-9600  
Fax 847-605-9610

[www.transystems.com](http://www.transystems.com)

Reference: Algonquin Road Grade Separation Preliminary Design Study  
Illinois Route 62 (Mount Prospect Road to Wolf Road)  
Cook County

Dear Mr. Evertte:

On behalf of the City of Des Plaines, TranSystems has initiated the preliminary design studies for the referenced project. To assist us in this project, we would appreciate you providing us with any available information as to the locations of your existing and proposed facilities adjacent to or within the study limits. The study limits extend along Algonquin Road between Mount Prospect Road and Wolf Road and along Union Pacific Railroad Milwaukee Subdivision 2,600 feet north and south of Algonquin Road. A project location map is enclosed for your reference.

The proposed improvements under study consist of:

- Roadway widening.
- Construction of the bridge over or under the UPRR.
- Profile modification along Algonquin Road.
- Construction of retaining walls.
- Sewer and water main replacement.

Please provide existing utility atlases for the project area and plans for any future work. Please provide the requested information by November 7, 2008 or provide a response letter if you do not have any facilities within the study limits.

Thank you for your assistance in this matter. If you have any questions or require additional information, please call me at (847) 407-5262 or e-mail me at [mlbeening@transystems.com](mailto:mlbeening@transystems.com).

Very truly yours,

TranSystems



Michael L. Beening

Enclosures

cc: Derek Peebles, P.E. - City of Des Plaines

Terrence J. O'Brien  
*President*  
Kathleen Therese Meany  
*Vice President*  
Gloria Alitto Majewski  
*Chairman of Finance*  
Frank Avila  
Patricia Horton  
Barbara J. McGowan  
Cynthia M. Santos  
Debra Shore  
Patricia Young

**Metropolitan Water Reclamation District of Greater Chicago**

100 EAST ERIE STREET CHICAGO, ILLINOIS 60611-3154 312-751-5600

September 15, 2008

Mr. Michael L. Beening  
TranSystems  
1051 Perimeter Drive  
Suite 1025  
Schaumburg, IL 60173

**RECEIVED**

SEP 17 2008



Dear Mr. Beening:

Subject: Algonquin Road Grade Separation Preliminary Study  
Illinois Route 62 (Mount Prospect Road to Wolf Road)  
Cook County

Reference is made to your letter dated September 12, 2008, concerning the subject project. The Metropolitan Water Reclamation District of Greater Chicago has reviewed the same and has no facilities or involvement within the area of the proposed project as shown on the attached sewer atlas sheets.

Very truly yours,

  
Amreek Paintal  
Engineer of Sewer Design

AP:ms  
Attachments



RECEIVED

SEP 24 2008



September 22, 2008

TranSystems  
Mr. Michael L. Beening  
1051 Perimeter Drive, Suite 1025  
Schaumburg, Illinois 60173

RE: Algonquin Road Grade Separation Preliminary Design Study  
Illinois Route 62 (Mount Prospect Road to Wolf Road)  
Cook County

Dear Mr. Beening:

AT&T has contracted the services of JMC Engineers & Associates, Inc. as a professional consultant to AT&T's Long Distance network for reviewing projects such as the one above.

In reviewing our cable mapping program, I find that AT&T Long Distance (T) is not involved with your project as engineered.

If you have any questions or concerns, please call me at 815-694-3000.

Sincerely,

Edward Varner  
Project Engineer  
Cc: Carl Donahue/OSPEC Supervisor, AT&T



Comcast Cable  
688 Industrial Drive  
Elmhurst, IL 60126

September 22, 2008

RECEIVED

SEP 27 2008

TranSystems  
1051 Perimeter Drive, Suite 1025  
Schaumburg, IL 60173  
Attention: Michael L. Beening



**Re: Utility atlas request  
Algonquin Road Grade Separation Preliminary Design Study  
Illinois Route 62 (Mount Prospect Road to Wolf Road)  
Cook County**

Dear Mr. Beening:

In regards to the above project, we have enclosed highlighted system drawings indicating Comcast aerial (yellow) and underground (magenta) cable facilities that are within the requested area.

If you have any questions relevant to this information, please feel free to call.

Very truly yours,

Robert L. Schalter Jr.  
Right-of-way Manager  
Greater Chicago Market

By:

Ted Wyman  
Right-of-Way Engineer  
(630) 600-6349

Encl. Dwg. No. 4229-6532, 4238-6532 & 4247-6532





Nicor Gas  
1844 Ferry Road  
Naperville, IL 60563-9600

Mailing Address:  
P.O. Box 190  
Aurora, IL 60507-0190

Phone 630 983-8676  
Internet www.nicor.com

September 24, 2008

Mr. Michael L. Beening  
TranSystems Corporation  
1051 Perimeter Drive, Suite 1025  
Schaumburg, Illinois 60173-5058

RECEIVED

SEP 27 2008

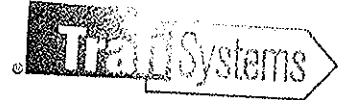

Re: **Algonquin Road Separation  
Illinois Route 62 – Mount Prospect Road to Wolf Road**

Dear Mr. Beening:

With reference to your request received on September 15, 2008, I am returning one set of atlas pages indicating the location of our gas main(s) in the area of your proposed project. The dimensions and location of Nicor Gas utility facilities as shown on these plans are an estimate for design purposes only, and are not intended for use as field locations for construction and are considered confidential. Please handle these pages accordingly.

If potential conflicts are anticipated, please supply us with a **large set** of pre-final plans **including right-of-way and cross-sections** or a copy of your electronic (Autocad) files and ample time for design and relocation of our mains and services (if necessary) to adhere to your tentative scheduled letting date. **NOTE: design analysis occurs after receipt of pre-final plans. Ample time requires a minimum of 6 months for design and planning.** This time does not take into consideration the installation our mains and services or reimbursable requirements if applicable.

Utility rights are generally documented through permit, license or easement and in some cases, Nicor Gas may own property. It is up to the requesting/design party(s) to research existing land rights of their proposed project. Nicor Gas will perform its own investigation to determine if any portion is reimbursable when construction is requested to relocate gas main.

Please phone JULIE, 1.800.892.0123, 48 hours prior to construction for location of our facilities within your proposed improvement.

Your project has been assigned Engineering # **M5389**. Please refer to this number in all future correspondence to assist with expediting any future inquiry.

Thank you for your cooperation in this matter.

Sincerely,

Constance Lane  
Engineering Administrator

ba: **M5389**  
attachments

## CH-Scott Czaplicki

---

**From:** CH-Mike Beening  
**Sent:** Wednesday, September 24, 2008 12:05 PM  
**To:** CH-Scott Czaplicki  
**Subject:** FW: Algonquin Rd drawing request  
**Attachments:** Segment B-0.pdf; Longhaul Fiber Annotations.pdf; Point Style Legend.pdf; Line Style Legend.pdf

---

**From:** Kidd, Marsha [mailto:Marsha.Kidd@Level3.com]  
**Sent:** Wednesday, September 24, 2008 9:08 AM  
**To:** CH-Mike Beening  
**Subject:** Algonquin Rd drawing request

Michael,

Attached are Level 3's facilities within the area indicated in your 09-12-08 letter. I've also included 3 PDF files which are keys to the as-built drawings.

After reviewing the information you provided, it is uncertain whether your project will impact our facilities.

For your information, Level 3's facilities have been constructed on private property and/or public right of way with the authorization of the applicable property owner.

Accordingly, Level 3 anticipates full reimbursement of all costs associated with the adjustment and/or relocation of its facilities prior to Level 3's performance of any work.

If, upon your review of the attached information, you determine that an adjustment and/or relocation of Level 3's facilities is necessary to accommodate your project, please contact me at 918-547-0029 or [Marsha.Kidd@Level3.com](mailto:Marsha.Kidd@Level3.com) to discuss the terms of any adjustment and/or relocation.

Please reference the file number **MW 20427** in any future correspondence regarding this job. Unless we hear from you directly, we will assume that any potential conflict has been eliminated.

Please note that this email applies to Level 3 Communications, LLC including all subsidiary and affiliate companies.

Thanks  
[Marsha Kidd](mailto:Marsha.Kidd@Level3.com)  
Level 3 Communications  
[Tel:918-547-0029](tel:918-547-0029)  
[Fax:720-567-1314](tel:720-567-1314)

## CH-Scott Czaplicki

---

**From:** Kalicki, Krzysztof [krzysztof.kalicki@verizonbusiness.com]  
**Sent:** Thursday, September 25, 2008 9:47 AM  
**To:** CH-Mike Beening  
**Subject:** Algonquin Rd (Mount Prospect Rd to Wolf Rd) Preliminary Design Study  
**Attachments:** MCI on Algonquin Rd.pdf

Michael,

See attached file for MCI fiber optic cable locations.

Regards,

Krzysztof (Kris) Kalicki  
MCI  
P.O. Box 387  
7719 W 60th PL  
Summit, IL 60501  
Office 708-924-9110  
Fax 708-458-6431



AT&T Legal Mandate Group  
1000 Commerce Drive, 2<sup>nd</sup> Floor  
Oak Brook, IL 60523

www.att.com

October 14, 2008

Mr. Michael Beening  
TranSystems  
1051 Perimeter Drive  
Suite 1025  
Schaumburg, IL 60173

RECEIVED

OCT 18 2008



**Subject: Facility Locate Request**

Reference: Algonquin Road Grade Separation Preliminary Design Study  
Illinois Route 62 (Mount Prospect Road to Wolf Road)  
Cook County

Dear Mr. Beening:

We have marked the general location of our facilities on the attached location map. The location of these facilities as shown is not to scale and should be used for preliminary design purposes only. Unfortunately, without field redlining and pot holing, we are not able to provide to scale locates or depth information for our facilities. When the scope of your project is more completely documented in drawings, we can provide more specific input to your project. Our goal is to be involved in your project during design so that we can work together and avoid any conflict with our existing facilities in the area of your project.

Please send any future correspondence and/or plans to the Legal Mandate Group at the address shown in the header of this letter.

Sincerely yours,

Hector Garcia  
[Hg2929@att.com](mailto:Hg2929@att.com)  
630-5735465

## CH-Scott Czaplicki

---

**From:** Wood, Randy [randy.wood@xo.com]  
**Sent:** Tuesday, November 11, 2008 8:54 AM  
**To:** CH-Mike Beening  
**Cc:** CH-Scott Czaplicki  
**Subject:** RE: Algonquin Road Improvements

Mike,

XO Communications has received your plans and we do not have any plant in the proposed area of construction.

Thanks,  
Randy Wood  
XO Communications  
630-371-3159

---

**From:** mlbeening@transystems.com [mailto:mlbeening@transystems.com]  
**Sent:** Tuesday, November 11, 2008 8:50 AM  
**To:** Wood, Randy  
**Cc:** SDCzaplicki@transystems.com  
**Subject:** Algonquin Road Improvements

Randy-

Per our phone conversation this morning, please find attached a copy of the initial letter sent to Mr. Glenn Luehrsen on September 12, 2008 along with Project Vicinity Map in PDF format for your records. Please respond through e-mail or letter indicating that your existing utility clear within our project limits for our records.

If you have questions or need additional information, please call.

Thanks for your time.

Mike Beening

Michael L Beening



TranSystems  
1051 Perimeter Drive, Suite 1025  
Schaumburg, IL 60173-5058  
Main: 847-605-9600  
Direct: 847-407-5262  
Cell: 847-812-2363  
Fax: 847-605-9610  
[www.transystems.com](http://www.transystems.com)

Note: The information contained in this transmission as well as all documents transmitted herewith are privileged and confidential information. This information is intended only for the use of the individual or entity to whom it was sent, and the recipient is obliged to protect this information as appropriate. If the recipient of the e-mail, and/or the documents attached is not the intended recipient, you are hereby notified that any dissemination, distribution or reproduction, copy, or storage of this communication is strictly prohibited. Thank you.

Commonwealth Edison Company [www.exeloncorp.com](http://www.exeloncorp.com)  
Libertyville Business Office  
1500 Franklin Boulevard  
Libertyville, Illinois 60048

November 5, 2008

**RECEIVED**

NOV 07 2008



Mr. Michael L. Beening  
TranSystems  
1051 Perimeter Drive, Suite 1025  
Schaumburg, Illinois 60173

**Re: Algonquin Road Grade Separation Preliminary Design Study  
Illinois Route 62 (Mount Prospect Road to Wolf Road)  
Cook County  
(ComEd Ref.# H7825MPR) Map Request**

Per your request, enclosed are copies of our maps depicting ComEd facilities in the subject area. This should assist you in locating these facilities and comparing with J.U.L.I.E. locates.

Please be aware that these maps are a functional representation only and are not intended to show exact locations. It is imperative that underground locates be made prior to any excavation. Please contact J.U.L.I.E. at 1-800-892-0123 to make arrangements. These maps are confidential and are not for redistribution to the general public. They are a representation of the electrical system as of the title block date, which is subject to change without notification.

If you have any questions, please contact me at 847-816-5521.

Respectfully,

A handwritten signature in black ink, appearing to read "Tim Tamason". The signature is fluid and cursive, with a large loop at the end.

Tim Tamason, Sr.Eng.Tech.  
ComEd – Public Relocation  
Cc: T. Bleck

AGENCY AND PROPERTY  
OWNER CORRESPONDENCE





**ITW Fastex**  
**195 Algonquin Road**  
**Des Plaines, Illinois 60016-6197**  
**Telephone 847.299.2222**  
**FAX 847.390.6183**

**ITW Fastex**  
**Plastic and Metal Components**

---

As of now, the main items of concern are:

1. Water supply to building and it potential interruption/re-route.  
(City water main is on opposite side of Algonquin Rd).
2. Algonquin Rd access relocation to the west, connecting our current main drive to this new access, 90° turn radius's for trucks/18 wheelers that will be required to attach current drive to new access.
3. Phone lines. (Current location unknown, but I believe it's on the North side of property).
4. Pond. Storm sewers and drainage tiles from our property feed our pond.
5. ITW Fastex Roadside sign impact/possible relocate.
6. Sewage line from building and it potential interruption/re-route
7. Other?

Electrical & Gas utilities enter from rear a property, so they are not a concern.

Bill March

Center turn lane for ~~west~~ <sup>aid</sup> traffic flow  
and hopefully help employees turning  
left (westbound) from facility.

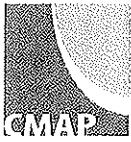

RECEIVED

August 29, 2008

SEP 04 2008



Hon. Tony Arredia  
Mayor  
City of Des Plaines  
1420 Miner Street  
Des Plaines, IL 60016

***Subject: Algonquin Road (IL 62) between Mount Prospect Road and Wolf Road  
City of Des Plaines***

Dear Mayor Arredia:

In response to a request made on your behalf and dated August 18, 2008, we have developed a year 2030 average daily traffic (ADT) projection of 12,000 for the subject location.

Traffic projections are developed using existing ADT data provided in the request letter and the results from the most recent (June, 2008 ) CMAP RTP/TIP Travel Demand Analysis. The regional travel model uses CMAP 2030 socioeconomic projections and assumes the implementation of the 2030 Regional Transportation Plan for the Northeastern Illinois area.

If you have any questions, please call Claire Bozic at (312) 386-8744.

Sincerely,

Donald P. Kopec  
Deputy Executive Director for Programming and Operations

cc: Yang (TranSystems)  
M:\proj1\ccb\forecasts\2008 Response\ck-16-08.doc

**Applicant:** TranSystems  
**Contact:** Scott Czaplicki  
**Address:** 1051 Perimeter Drive  
Schaumburg, IL 60173

**IDNR Project #:** 0903087  
**Date:** 10/09/2008

**Project:** Algonquin Road Feasibility Study  
**Address:** 200E. Algonquin Road, Des Plaines

**Description:** Proposed grade separation of Algonquin Road and UPRR between Mt. Prospect Road and Wolf Road

---

### Natural Resource Review Results

---

*This project was submitted for information only. It is not a consultation under Part 1075.*

The Illinois Natural Heritage Database contains no record of State-listed threatened or endangered species, Illinois Natural Area Inventory sites, dedicated Illinois Nature Preserves, or registered Land and Water Reserves in the vicinity of the project location.

#### **Location**

The applicant is responsible for the accuracy of the location submitted for the project.

**County:** Cook

**Township, Range, Section:**

41N, 11E, 24                      41N, 12E, 19



**IL Department of Natural Resources Contact**  
Impact Assessment Section  
217-785-5500  
Division of Ecosystems & Environment

### **Disclaimer**

The Illinois Natural Heritage Database cannot provide a conclusive statement on the presence, absence, or condition of natural resources in Illinois. This review reflects the information existing in the Database at the time of this inquiry, and should not be regarded as a final statement on the site being considered, nor should it be a substitute for detailed site surveys or field surveys required for environmental assessments. If additional protected resources are encountered during the project's implementation, compliance with applicable statutes and regulations is required.

### **Terms of Use**

By using this website, you acknowledge that you have read and agree to these terms. These terms may be revised by IDNR as necessary. If you continue to use the EcoCAT application after we post changes to these terms, it will mean that you accept such changes. If at any time you do not accept the Terms of Use, you may not continue to use the website.

1. The IDNR EcoCAT website was developed so that units of local government, state agencies and the public could request information or begin natural resource consultations on-line for the Illinois Endangered Species Protection Act, Illinois Natural Areas Preservation Act, and Illinois Interagency Wetland Policy Act. EcoCAT uses databases, Geographic Information System mapping, and a set of programmed decision rules to determine if proposed actions are in the vicinity of protected natural resources. By indicating your agreement to the Terms of Use for this application, you warrant that you will not use this web site for any other purpose.
2. Unauthorized attempts to upload, download, or change information on this website are strictly prohibited and may be punishable under the Computer Fraud and Abuse Act of 1986 and/or the National Information Infrastructure Protection Act.
3. IDNR reserves the right to enhance, modify, alter, or suspend the website at any time without notice, or to terminate or restrict access.

### **Security**

EcoCAT operates on a state of Illinois computer system. We may use software to monitor traffic and to identify unauthorized attempts to upload, download, or change information, to cause harm or otherwise to damage this site. Unauthorized attempts to upload, download, or change information on this server is strictly prohibited by law. Unauthorized use, tampering with or modification of this system, including supporting hardware or software, may subject the violator to criminal and civil penalties. In the event of unauthorized intrusion, all relevant information regarding possible violation of law may be provided to law enforcement officials.

### **Privacy**

EcoCAT generates a public record subject to disclosure under the Freedom of Information Act. Otherwise, IDNR uses the information submitted to EcoCAT solely for internal tracking purposes.



U.S. ENVIRONMENTAL PROTECTION AGENCY

# Superfund Information Systems

[Recent Additions](#) | [Contact Us](#) | [Print Version](#) Search:  **GO**

[EPA Home](#) > [Superfund](#) > [Sites](#) > [Superfund Information Systems](#) > [Search Superfund Site Information](#) > Search Results

- Superfund Site Information
- Site Documents
- Data Element Dictionary (DED)
- Order Superfund Products

## Superfund Site Information

### Search Results

**Search Criteria:**

Active vs. Archived: **Active** [What are active and archived sites?](#)  
 City: **DES PLAINES**  
 State(s): **Illinois**

Found 1 site(s) that match your search criteria listed above.  
 To conduct another search, return to the [Search Superfund Site Information](#) page or request a [Customized SIS Report](#).

[Save results in Excel format](#)

Displaying sites 1 through 1

EPA ID ▼	Site Name ▼	City ▼	County ▼	State ▼	NPL Status ▼
ILN000508117	<a href="#">DESPLAINES ASBESTOS TRAILER</a>	DES PLAINES	COOK	IL	Not NPL

Displaying sites 1 through 1

DISCLAIMER: Be advised that the data contained in these profiles are intended solely for informational purposes use by employees of the U.S. Environmental Protection Agency for management of the Superfund program. They are not intended for use in calculating Cost Recovery Statutes of Limitations and cannot be relied upon to create any rights, substantive or procedural, enforceable by any party in litigation with the United States. EPA reserves the right to change these data at any time without public notice.

[OSWER Home](#) | [Superfund Home](#)

---

[EPA Home](#) | [Privacy and Security Notice](#) | [Contact Us](#)

URL: <http://cfpub.epa.gov/supercpad/cursites/srchrslt.cfm>  
 This page design was last updated on Tuesday, October 16, 2007  
 Content is dynamically generated by ColdFusion



## U.S. ENVIRONMENTAL PROTECTION AGENCY

## Superfund Information Systems

[Recent Additions](#) | [Contact Us](#) | [Print Version](#) Search: **GO**[EPA Home](#) > [Superfund](#) > [Sites](#) > [Superfund Information Systems](#) > [Search Superfund Site Information](#)  
> [Search Results](#) > DESPLAINES ASBESTOS TRAILERSuperfund Site  
Information

Site Documents

Data Element  
Dictionary (DED)Order Superfund  
Products

## Superfund Site Information

## DESPLAINES ASBESTOS TRAILER

## Site Information

[Site Info](#) | [Aliases](#) | [Operable Units](#) | [Contacts](#)  
[Actions](#) | [Contaminants](#) | [Site-Specific Documents](#)**Site Name:** DESPLAINES ASBESTOS TRAILER**Street:** 555 E. HOWARD**City / State / ZIP:** DES PLAINES, IL 60018**NPL Status:** Not on the NPL**Non-NPL Status:** Removal Only Site (No Site Assessment Work Needed)**EPA ID:** ILN000508117**EPA Region:** 05**County:** COOK**Federal Facility Flag:** Not a Federal Facility[Return to Search Results](#)[Return to Search Superfund Site  
Information](#)

DISCLAIMER: Be advised that the data contained in these profiles are intended solely for informational purposes use by employees of the U.S. Environmental Protection Agency for management of the Superfund program. They are not intended for use in calculating Cost Recovery Statutes of Limitations and cannot be relied upon to create any rights, substantive or procedural, enforceable by any party in litigation with the United States. EPA reserves the right to change these data at any time without public notice.

[OSWER Home](#) | [Superfund Home](#)

---

[EPA Home](#) | [Privacy and Security Notice](#) | [Contact Us](#)

URL: <http://cfpub.epa.gov/supercpad/cursites/csitinfo.cfm>  
This page design was last updated on Tuesday, October 16, 2007  
Content is dynamically generated by ColdFusion



[www.epa](http://www.epa)

Rod R. Blagoje

[L.I.T. Search](#)

**IEMA #** 892105

**LPC #** 0310630005

**IEMA Date:** 10/23/1989

**Site:** Borg-Warner Automotive

**Address:** 1200 South Wolf Rd.  
Des Plaines, IL. 60018

**County:** Cook

**Regulated by:** 731

**Products:** Gasoline

**20 Day Rpt:**

**45 Day Rpt:**

**Project Manager:** NOT ASSIGNED

**Phone:**

**Email:** \_

<a href="#">Tank Operator</a>	<a href="#">General</a>	<a href="#">Title XVI</a>	<a href="#">TACO</a>	<a href="#">Claims</a>	<a href="#">Search</a>
-------------------------------	-------------------------	---------------------------	----------------------	------------------------	------------------------

Copyright © 2003 Illinois EPA [Agency Site Map](#) | [Privacy Information](#) | [Kids Privacy](#) | [Web Accessibility](#) | [Agency Webmaster](#)



[www.epa](http://www.epa)

Rod R. Blagoje

[L.I.T. Search](#)

**IEMA #** 890845

**LPC #** 0310635189

**IEMA Date:** 5/24/1989

**Site:** Shell Oil Co.

**Address:** 1190 Wolfe Rd.

Des Plaines, IL. 60016

**County:** Cook

**Regulated by:** 731

**Products:** Gasoline

**20 Day Rpt:** 3/6/2002

**45 Day Rpt:** 3/6/2002

**Project Manager:** Valerie Davis

**Phone:** (217) 785-7492

**Email:** [Valerie.A.Davis@illinois.gov](mailto:Valerie.A.Davis@illinois.gov)

<a href="#">Tank Operator</a>	<a href="#">General</a>	<a href="#">Title XVI</a>	<a href="#">TACO</a>	<a href="#">Claims</a>	<a href="#">Search</a>
-------------------------------	-------------------------	---------------------------	----------------------	------------------------	------------------------

Copyright © 2003 Illinois EPA [Agency Site Map](#) | [Privacy Information](#) | [Kids Privacy](#) | [Web Accessibility](#) | [Agency Webmaster](#)





# Illinois Environmental Protection Agency

[www.epa](http://www.epa.state.il.us)

Rod R. Blagoje

[L.I.T. Search](#)

**IEMA #** 891272

**LPC #** 0310635194

**IEMA Date:** 7/19/1989

---

**Site:** Algonquin School

---

**Address:** 767 Algonquin Rd.

Des Plaines, IL. 60016

**County:** Cook

**Regulated by:** 731

**Products:** Fuel Oil

---

**20 Day Rpt:**

**45 Day Rpt:**

**Project Manager:** NOT ASSIGNED

**Phone:**

**Email:** \_

<a href="#">Tank Operator</a>	<a href="#">General</a>	<a href="#">Title XVI</a>	<a href="#">TACO</a>	<a href="#">Claims</a>	<a href="#">Search</a>
-------------------------------	-------------------------	---------------------------	----------------------	------------------------	------------------------

Copyright © 2003 Illinois EPA [Agency Site Map](#) | [Privacy Information](#) | [Kids Privacy](#) | [Web Accessibility](#) | [Agency Webmaster](#)



[L.I.T. Search](#)

**IEMA #** 891019

**LPC #** 0310630007

**IEMA Date:** 6/16/1989

---

**Site:** UOP Corp.

---

**Address:** 50 East Algonquin Rd.  
Des Plaines, IL. 60017

**County:** Cook

**Regulated by:** 731

**Products:** Gasoline, Diesel

---

**20 Day Rpt:**

**45 Day Rpt:**

**NFR Date:** 1/19/2001

**Recorded:** 3/2/2001

**Project Manager:** Valerie Davis

**Phone:** (217) 785-7492

**Email:** [Valerie.A.Davis@illinois.gov](mailto:Valerie.A.Davis@illinois.gov)

<a href="#">Tank Operator</a>	<a href="#">General</a>	<a href="#">Title XVI</a>	<a href="#">TACO</a>	<a href="#">Claims</a>	<a href="#">Search</a>
-------------------------------	-------------------------	---------------------------	----------------------	------------------------	------------------------



[www.epa](http://www.epa)

Rod R. Blagoje

[L.I.T. Search](#)

**IEMA #** 980532

**LPC #** 0310635443

**IEMA Date:** 3/11/1998

**Site:** Balagam, Mary

**Address:** 1205 South Wolf Rd.  
Des Plaines, IL. 60018

**County:** Cook

**Regulated by:** 732

**Site Classification:** High

**Products:** Gasoline

**20 Day Rpt:**

**45 Day Rpt:** 12/14/2004

**Project Manager:** Steve Jones

**Phone:** (217) 524-1253

**Email:** [Steve.Jones@illinois.gov](mailto:Steve.Jones@illinois.gov)

<a href="#">Tank Operator</a>	<a href="#">General</a>	<a href="#">Title XVI</a>	<a href="#">TACO</a>	<a href="#">Claims</a>	<a href="#">Search</a>
-------------------------------	-------------------------	---------------------------	----------------------	------------------------	------------------------

Copyright © 2003 Illinois EPA [Agency Site Map](#) | [Privacy Information](#) | [Kids Privacy](#) | [Web Accessibility](#) | [Agency Webmaster](#)

### Pace Park-n-Ride and Bus Route Mapping



- Legend**
- Park and Ride
  - Pace Bus Route
  - Interstate
  - US Highway
  - State Highway
  - Ramp
  - Major Road
  - County



Map created at Thursday, August 21.

# U.S. DOT - CROSSING INVENTORY INFORMATION AS OF 5/5/2008

Crossing No.: 174098L                      Update Reason: Changed Crossing                      Effective Begin-Date of Record: 02/12/08  
 Railroad: UP    Union Pacific RR Co. [UP ]                      End-Date of Record:  
 Initiating Agency Original                      Type and Position: Public At Grade

## Part I Location and Classification of Crossing

Division:	CHICAGO	State:	IL
Subdivision:	NEW LINE	County:	COOK
Branch or Line Name:	VALLEY	City:	In DES PLAINES
Railroad Milepost:	0010.53	Street or Road Name:	ALGONQUIN RD
RailRoad I.D. No.:		Highway Type & No.:	FAU3514
Nearest RR Timetable Stn:	NORMA	HSR Corridor ID:	
Parent Railroad:		County Map Ref. No.:	11
Crossing Owner:		Latitude:	41.9509700
ENS Sign Installed:		Longitude:	-87.9149020
Passenger Service:		Lat/Long Source:	Neither
Avg Passenger Train Count:	0	Quiet Zone:	
Adjacent Crossing with Separate Number:			

### Private Crossing Information:

Category:		Public Access:	Unknown
	Specify Signs:		Specify Signals:
	ST/RR A	ST/RR B	ST/RR C
			ST/RR D

Railroad Use:

State Use:

Narrative:

Emergency Contact:

Railroad Contact:

State Contact:

## Part II Railroad Information

Number of Daily Train Movements:		Less Than One Movement Per Day:	No
Total Trains:	47	Total Switching:	9
Typical Speed Range Over Crossing: From	10	to	30 mph
Day Thru:		Maximum Time Table Speed:	50
Type and Number of Tracks:	Main: 2	Other:	0
		Specify:	
Does Another RR Operate a Separate Track at Crossing?			No
Does Another RR Operate Over Your Track at Crossing?			Yes: CP

# U.S. DOT - CROSSING INVENTORY INFORMATION

Crossing 174098L

Continued

Effective Begin-Date of Record: 02/12/08

End-Date of Record:

## Part III: Traffic Control Device Information

Signs:

Crossbucks:	2	Highway Stop Signs:	0
Advanced Warning:	Yes	Hump Crossing Sign:	
Pavement Markings:	Stop Lines and RR Xing Symbols	Other Signs:	2      Specify: 2TRACKS
			0

Train Activated Devices:

Gates:	2	4 Quad or Full Barrier:	
Mast Mounted FL:	0	Total Number FL Pairs:	0
Cantilevered FL (Over):	0	Cantilevered FL (Not over):	0
Other Flashing Lights:	0	Specify Other Flashing Lights:	
Highway Traffic Signals:	0	Wigwags:	0      Bells: 1
Other Train Activated Warning Devices:		Special Warning Devices Not Train Activated:	
Channelization:		Type of Train Detection:	Constant Warning Time
Track Equipped with Train Signals?	Yes	Traffic Light Interconnection/Preemption:	

## Part IV: Physical Characteristics

Type of Development:	Industrial	Smallest Crossing Angle:	60 to 90 Degrees
Number of Traffic Lanes Crossing Railroad:	2	Are Truck Pullout Lanes Present?	No
Is Highway Paved?	Yes	If Other:	
Crossing Surface:	Concrete	Is it Signalized?	
Nearby Intersecting Highway?	N/A	Is Crossing Illuminated?	
Does Track Run Down a Street?	No		
Is Commercial Power	Yes		

## Part V: Highway Information

Highway System:	Other FA Highway - Not NHS	Functional Classification of Road at Crossing:	Urban Minor Arterial
Is Crossing on State Highway System:	Yes		
Annual Average Daily Traffic (AADT):	011100	AADT Year:	2006
Estimated Percent Trucks:	05	Avg. No of School Buses per Day:	0
Posted Highway Speed:	35		

APPENDIX C  
DESIGN CRITERIA





## GEOMETRIC DESIGN CRITERIA

Design Element	Criteria	Reference Location
Highway Type or Classification	Minor Arterial (Urban)	IDOT
Design Year	2030	BLRS Figure 32-2D
Design Traffic	12,000	Chicago Metropolitan Agency for Planning; Letter
<b><u>Roadway Horizontal Design</u></b>		
Design Speed	40 MPH	BLRS Figure 32-2D
Posted Speed	35 MPH	
R.O.W.. Width	Algonquin Road - 100'; UPRR -110'	
Access Control	No	
Travel Lanes	4	BLRS Figure 32-2D
Design Lane Width	12' (11' Min)	BLRS Figure 32-2D
Median Width	12' Flush TWLTL	BLRS Figure 32-2D
Crown/cross slopes	1.5-2%	BLRS Figure 32-2D
Sidewalk Width	5'	BLRS Figure 32-2D
Sidewalk (Adjacent to Curb)	7'	IDOT District 1 Policy
Sidewalk Grade	5%	ADA 4.8.1 (No landing area)
Curbs	B-6.18 or B-6.24	BLRS Figure 32-2D / Adjacent sections
Parking	No	
Bicycle Lane / Shared Path	Yes	Des Plaines GIS/Chicago Bicycle Federation
Bicycle Path Width - At Grade	10' + 2' Shoulders	BDE 17-2.02(d), BDE Figure 17-2Y
Bicycle Path Width - Structure	10' (Min)' 14' (Desirable)	BDE 17-2.02 (l); BDE Figure 17-2AM
Driveway Gradient	Residential (8%); Commercial (6%)	IDOT Access to State Highways
Clear Zone	1.5' From Face of Curb 10' from Back of Curb	BLRS Figure 32-2D BDE 34-4.04
<b><u>Road Vertical Alignment</u></b>		
Maximum Grade	7%	BLRS Figure 32-3B
Design Maximum Grade	5%	ADA 4.8.1 (No landing area)
Minimum Grade	0.30%	BLRS Figure 32-3B
Design Minimum Grade	0.50%	BLRS Figure 32-3B
Vertical Curvature	Crest 44 Sag 64; KMax 167	BLRS Figure 32-3B BLRS Figure 32-3B
Minimum Vertical Curve Length	120	BLRS 30-2.02(b)
Stopping Sight Distance	305	BLRS Figure 32-3B
Low Point Requirements	100' from side of bridge	BDE 33-6.04(h)

GEOMETRIC DESIGN CRITERIA

Design Element	Criteria	Reference Location
<b><u>Bridges</u></b>		
Vertical Clearance (Rail Over)	14' - 9"	BLRS Figure 36-4I
Vertical Clearance (Rail Under)	23' - 4"	BNSF/UPRR Guidelines for Railroad Grade Separations; Std 711100
Design Vertical Clearance (Rail Under)	23' - 6"	Additional 2" allowed for Ballast Resurfacing
Horizontal Clearance	25' (18' min) from CL of Track (Crashwall if <25')	BNSF/UPRR Guidelines for Railroad Grade Separations; 5.2.2
Bridge Approach Pavement	30'	IDOT Highway Standard 420401
<b><u>Rail</u></b>		
Typical Section	13.5' (min) to Top of Subballast (High Density) 3' (min) from Toe to bottom of ditch	UPRR Standard Drawing 0001B UPRR Standard Drawing 0001B
Max Shoofly Speed (North of Algonquin)	50 mph	UPRR Milwaukee Subdivision (152) Time Table
Max Shoofly Speed (South of Algonquin)	10 mph	UPRR Milwaukee Subdivision (152) Time Table
Min Distance from P.S. (Same Direction)	60', 150' (Min, Preferred)	UPRR Standard Drawing 0017A
Min Distance from P.S. (Reverse Curve)	60, 100' (Min, Preferred)	UPRR Standard Drawing 0017A
<b><u>Rail Horizontal Alignment</u></b>		
Minimum Spiral Length	33' per 3/4" Superelevation (Ea)	UPRR Standard Drawing 0019A
Superelevation	Use 1" Imbalance	UPRR Standard Drawing 0021C
Shoofly Design Speed O2	40 mph	Based on Existing Restrictions
Shoofly Design Curve	2.5 Degrees	Based on Existing Restrictions
Minimum Tangent Distance	300'	UPRR Standard Drawing 0018
<b><u>Rail Vertical Alignment</u></b>		
Design Maximum Vertical Grade	0.65%	O'Hare Modernization Program Contract Plans
Maximum V/L Summit (V/L =  G2-G1 /L)	0.10	UPRR Standard Drawing 0016
Maximum V/L Sag (V/L =  G2-G1 /L)	0.06	UPRR Standard Drawing 0016

Design Element		Manual Section	Two-Way DHV < 1250 (1)	Two-Way DHV 1250-2050 (1)	Two-Way DHV 2050-2900 (1)	
Design Controls	Highway Type	—	TWS-2	TWS-4	TWS-6	
	Design Forecast Year	27-6.02	20 Years	20 Years	20 Years	
	* Design Speed	27-5.02	30 mph – 40 mph	30 mph – 40 mph	30 mph – 40 mph	
	* Level of Service (2)	27-6.04	C			
Cross Section Elements	* Surface Width	Number of Travel Lanes	31-1.02	2	4	6
		Travel Lane	31-1.01	Des: 12' Min: 11' (3)	Des: 12' Min: 11'	
		Travel Lane (Shared with Bicycles)	42-3.02	Des: 14' Min: 13'		
		Parking Lane (4)	31-1.04	Des: 10' Min: 8'		
		Auxiliary Lane	31-1.03	Single Left & Right: Des: 12', Min: 11' Dual Lefts & Rights: Des: 24', Min: 22'		
	Cross Slope	*Travel Lanes (Minimum)	31-1.08	1.5% - 2%	1.5% - 2% (5a)	
		Auxiliary Lanes		2% (5b)	(5b)	
	Outside Curb and Gutter Type		31-1.07	B-6.24, B-6.18 or B-6.12 CC&G (6)		
	Median Width	Flush	31-1.05	N/A	Range: 4'/14'	
		Flush TWLTL		Des: 12' Range: 10'/14'		
		Traversable		N/A	16'	
		Raised-Curb		N/A	18'	
	Sidewalk Width (7)		31-2.02	Des: 5' Min: 4'		
* Clear Zone (8)		35-2	1.5'			
Roadway Slopes	Side Slopes (9)	Cut Section (Curbed)	31-2.03	—	—	—
		Rock Cut	—	—	—	—
		Fill Section (Curbed)	—	—	—	—
	Median Slopes	Concrete Surface/Traversable	31-1.05	N/A	1.5%	
		Flush/TWLTL Surface		1.5%		
Grass/Landscape Surface		N/A		5% (Towards C&G)		

\* Controlling design criteria (see Section 27-7).

TWS = Two-Way Street

**GEOMETRIC DESIGN CRITERIA FOR URBAN TWO-WAY ARTERIALS (New Construction/Reconstruction)**  
**Figure 32-2D (US Customary)**

- (1) Traffic Volumes. The design hourly volumes (DHV) are calculated using a PHF = 1.0; these values may be adjusted using local peak-hour factors. For more information, see the *Highway Capacity Manual*.
- (2) Level of Service. A Level of Service D may be used in heavily developed sections of metropolitan areas.
- (3) Surface Width. Provide a minimum width of 30 ft (9.0 m) face-of-curb to face-of-curb.
- (4) Parking Lane Width. The desirable width of the parking lane is 10 ft (3.0 m) and includes the gutter width. If the parking lane may be used as future travel lane, the 10 ft (3.0 m) width should be in addition to the gutter width. An 8 ft (2.4 m) width may be used where it is unlikely the parking lane will be used as through or turning lane in the future.
- (5) Cross Slope.
  - (a) Use 2.0% minimum cross slopes for travel lanes not adjacent to the crown.
  - (b) Curbed left-turn lanes may be sloped at 1.5% to 2.0% away from the median. TWLTL and flush left-turn lanes are sloped at the same rate as the adjacent traveled way. Cross slopes for outside auxiliary lanes will be at least 2.0% and desirably should be 0.5% greater than the adjacent travel lane.
- (6) Gutter Width. Under restricted conditions, the gutter width adjacent to the edge of a 12 ft (3.6 m) turn lane may be eliminated.
- (7) Sidewalk Width. Include a 2 ft to 3 ft (600 mm to 1.0 m) buffer strip between the curb and sidewalk. For sidewalks without a buffer strip, provide a 6 ft (1.8 m) sidewalk width behind the curb.
- (8) Clear Zone. Distance is measured from the face of the curb.
- (9) Side Slopes. Side slopes to be determined on a case-by-case basis considering roadside development and right-of-way restrictions.

## GEOMETRIC DESIGN CRITERIA FOR URBAN TWO-WAY ARTERIALS (New Construction/Reconstruction)

### Footnotes for Figure 32-2D

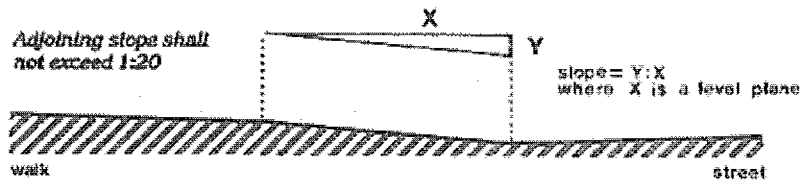
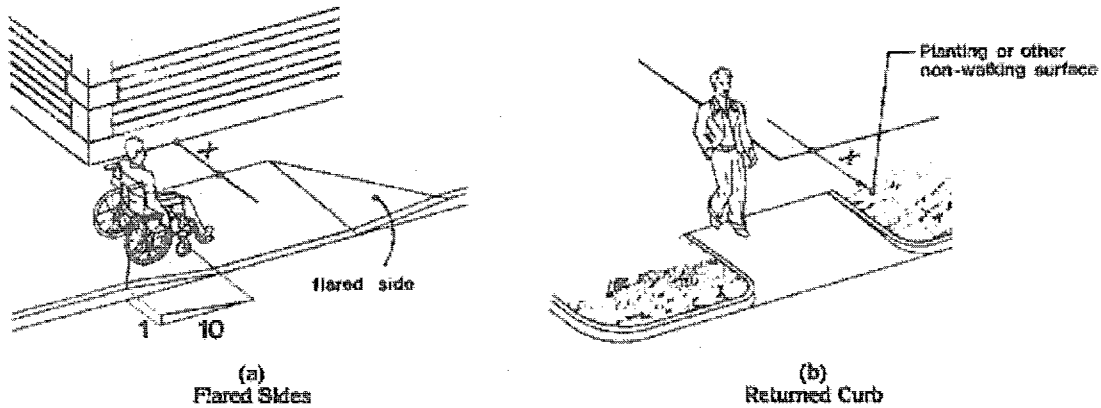

Fig. 11  
Measurement of Curb Ramp Slopes



If X is less than 48 in,  
then the slope of the flared side  
shall not exceed 1:12.

Fig. 12  
Sides of Curb Ramps

**4.7.11 Islands.** Any raised islands in crossings shall be cut through level with the street or have curb ramps at both sides and a level area at least 48 in (1220 mm) long between the curb ramps in the part of the island intersected by the crossings (see Fig. 15(a) and (b)).

**4.8 Ramps.**

**4.8.1\* General.** Any part of an accessible route with a slope greater than 1:20 shall be considered a ramp and shall comply with 4.8.

**4.8.2\* Slope and Rise.** The least possible slope shall be used for any ramp. The maximum slope of a ramp in new construction shall be 1:12. The maximum rise for any run shall be 30 in (760 mm) (see Fig. 16). Curb ramps and

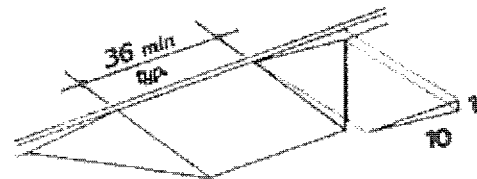
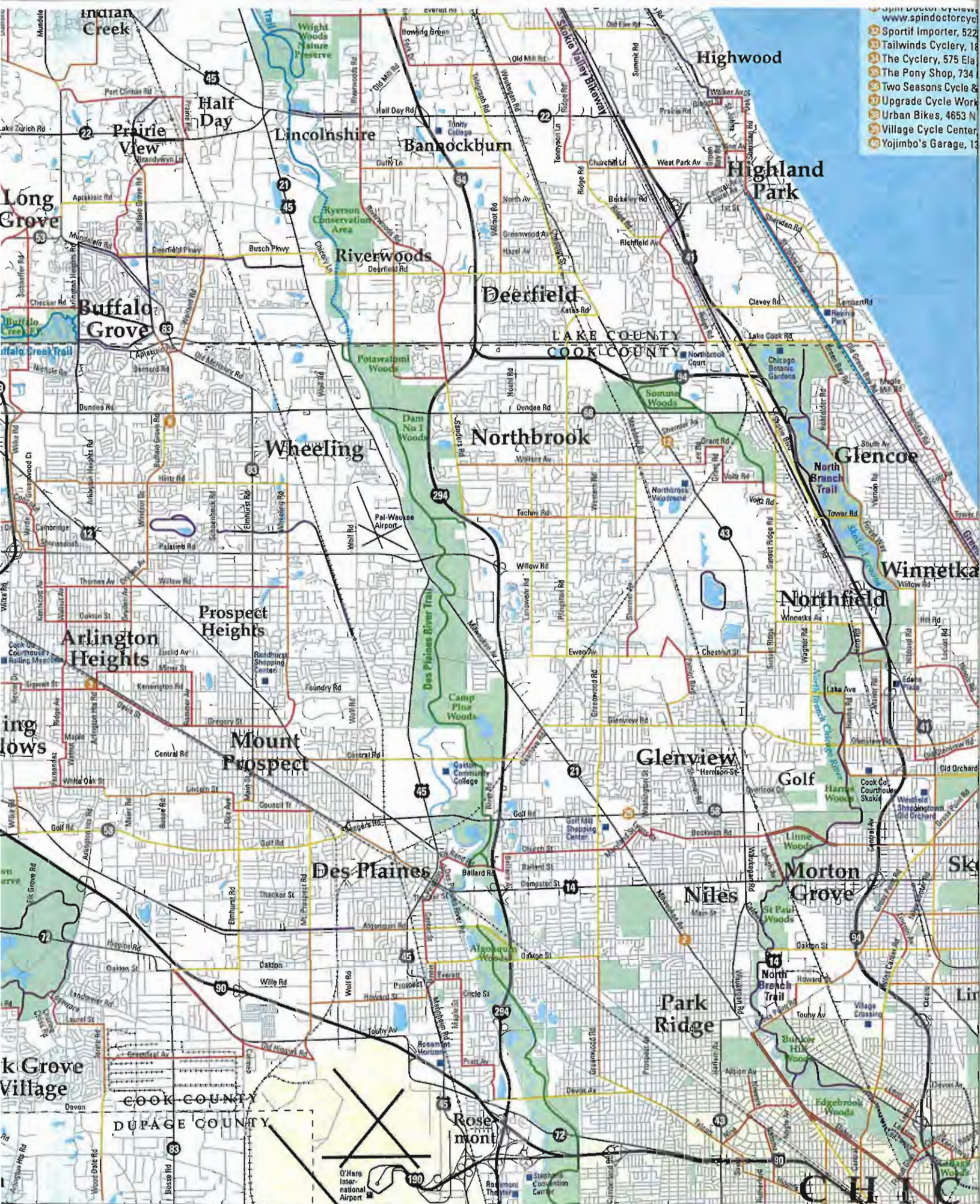

Fig. 13  
Built-Up Curb Ramp

ramps to be constructed on existing sites or in existing buildings or facilities may have slopes and rises as *allowed in 4.1.6(3)(a)* if space limitations prohibit the use of a 1:12 slope or less.



- www.spindactorcycles.com
- Sportif Importer, 522
- Tailwinds Cyclery, 18
- The Cyclery, 575 Ela
- The Pony Shop, 734
- Two Seasons Cycle &
- Upgrade Cycle Work
- Urban Bikes, 4653 N
- Village Cycle Center,
- Yojimbo's Garage, 13

**CHICAGO**

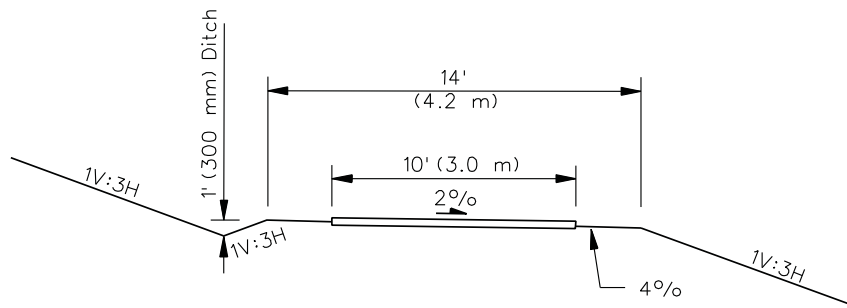

TYPICAL BIKE PATH FOR MINIMAL SHARED USE

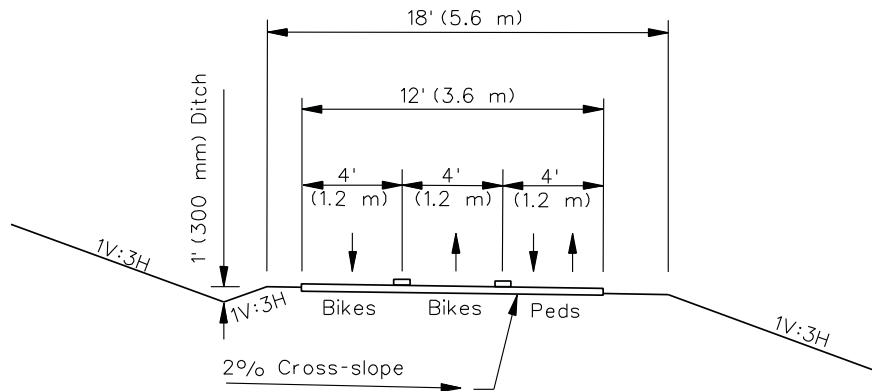

TYPICAL BIKE PATH FOR SUBSTANTIAL SHARED USE  
(Optional Striping Shown)

**CROSS SECTIONS FOR TWO-WAY, SHARED-USE BICYCLE PATHS**  
**Figure 17-2Y**

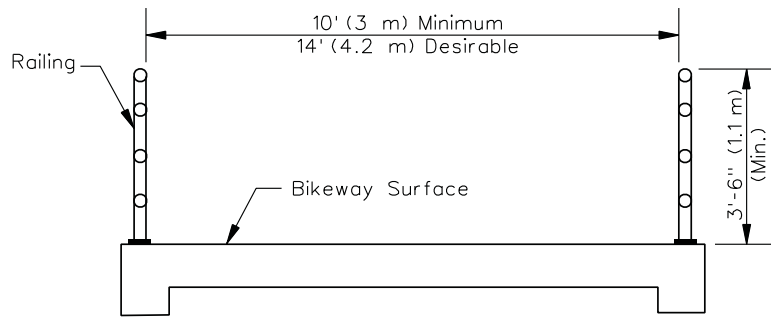

BRIDGE CROSS SECTION

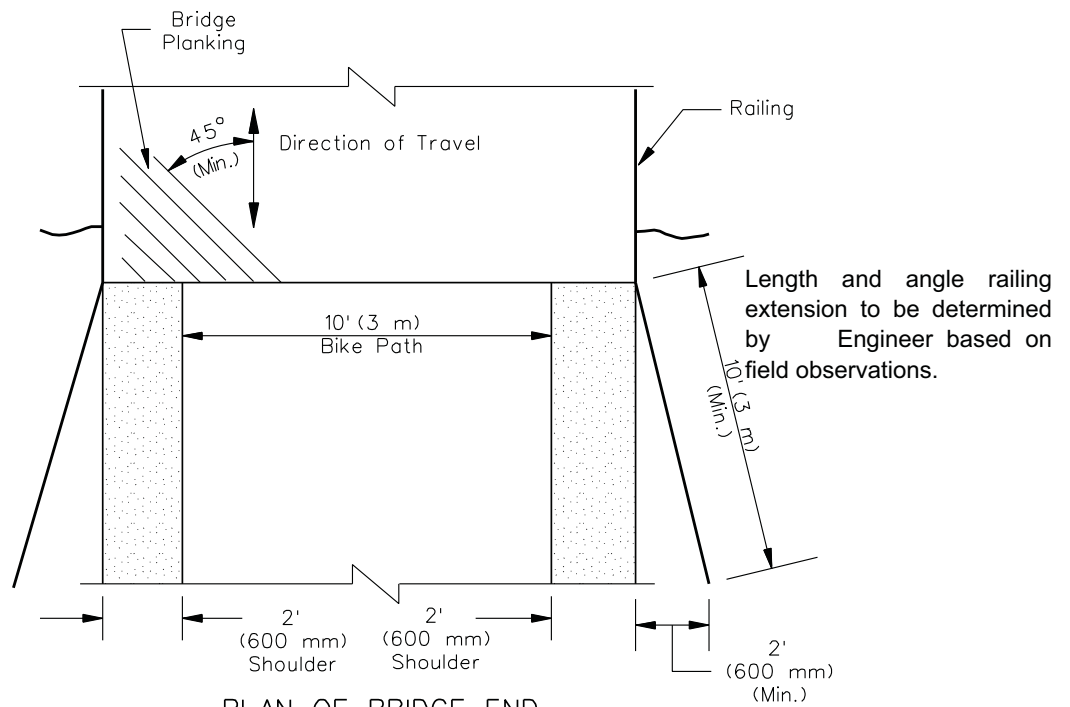

PLAN OF BRIDGE END

**PLAN AND CROSS SECTION OF BIKE PATH BRIDGE WITH RAILING EXTENSION**

**Figure 17-2AM**



merely a commercial entrance since these are not permitted along a freeway where the access rights were purchased.

### C. Design Requirements

- 1) Alignment - Intersecting roadways are points of conflict and hence are potentially hazardous. Intersections on curved alignment or on grades tend to increase this potential. Since some hazards are experienced while turning and braking on a curved alignment, particularly on wet pavements, flat horizontal and vertical controls should be the objective.

It is desirable for proposed streets or roads to intersect State highways at right angles. However, if the intersection must be skewed, it is desirable the angle not be less than 75 degrees with an absolute minimum of 60 degrees.

Stop-controlled approaches to State highways on curved alignment require special attention, especially in rural areas. The Bureau of Location and Environment's "Manual of Policies and Procedures" contains guidelines regarding alignment at such intersections.

- 2) Grades - All side road connections in rural locations shall have a grade that slopes downward and away from the highway pavement surface at a rate of not less than 1/8 inch nor more than 1/2 inch per foot. This slope should continue for 50 to 100 feet or, as a minimum, to the beginning of the radius returns on the side road. When the State highway is being intersected on a curve and the pavement is superelevated, the maximum desirable "breakover" (algebraic difference between the pavement and the side road slopes) is 6%. A maximum of 10% "breakover" is permissible when field conditions warrant.

The grades of street approaches in urban locations shall be compatible with the provisions for drainage of the existing designed cross section. The grade used shall accommodate the flow of drainage in the vicinity of the connection and should be designed so that future widening of the highway would not require major reconstruction of the intersection.

Beyond the initial slope away from the State highway, the grades are to be within the maximums for rural roads in the Bureau of Local Roads and Street's policies and for urban streets in the Bureau of Location and Environment's policies.

- 3) General and Geometric Requirements - Other requirements for urban streets and rural roads may be found in the Bureau of Local Roads and Street's "Administrative Policies" manual. However, within the limits of the State highway right-of-way, the minimum rural cross-section shall be a 24-foot roadway surface with 4-foot shoulders and a 30-foot minimum roadway surface for an urban cross section. Also, in both rural and urban areas, the roadway and flare shall be either portland cement concrete or bituminous plant mix on a suitable base course. The specific type of material and thickness will be specified in the permit. The surfacing shall extend to the right-of-way line or 50 feet from the edge of the pavement, whichever is less, but must include the entire radius return.

### **34-4.03(b) Material and Soils Conditions**

The designer must ensure that permanent erosion control is considered in the design of ditches in cut slopes. The designer should contact the district landscape architect and the district geotechnical engineer, who will review the existing soils conditions to determine if additional measures may be required to control erosion (e.g., additional topsoil, special plantings, paving). It will be the designer's responsibility to consider their recommendations for incorporation into the plans. As a general guide, longitudinal ditch slopes less than 1% can be seeded, slopes of 1% to 3% usually will require sodding or seeding with an erosion control blanket, and slopes greater than 3% will require riprap or other protective lining. Very flat longitudinal ditch slope (i.e., < 0.4%) may require a paved ditch so as to maintain the flowline over time. For more information on the design of ditch linings, the designer should review Chapter 40 in the *BDE Manual* and the *IDOT Drainage Manual*.

### **34-4.03(c) Hydraulic Design**

Roadside and median ditches are to be designed according to the criteria presented in Chapter 40 and the *IDOT Drainage Manual*. The use of these criteria will ensure the proper drainage of the pavement subgrade and the adequate conveyance of surface flow without creating erosion of ditch sections.

### **34-4.04 Cut Sections With Curbs**

On facilities with curbs, a shelf is provided with a back slope beyond the shelf. The shelf is usually sloped towards the roadway to eliminate the need for a separate drainage system behind the curb. Where sidewalks are present or anticipated in the future, provide a shelf width of 10 ft (3.0 m) with a cross slope of 2%. Where sidewalks are not present or anticipated in the future, the shelf cross slope should be 5% to provide for adequate drainage. This criteria is illustrated in Figure 34-4D.

Where the height of a cut exceeds 30 ft (9 m), consider benching the back slope to minimize erosion problems. Approximately halfway down the slope, provide a bench with a V-type ditch. On short sections, the bench can be graded to drain to one side. For longer sections, grade the bench to drain from both directions. For additional guidance on benching designs, the designer should contact the district geotechnical engineer.

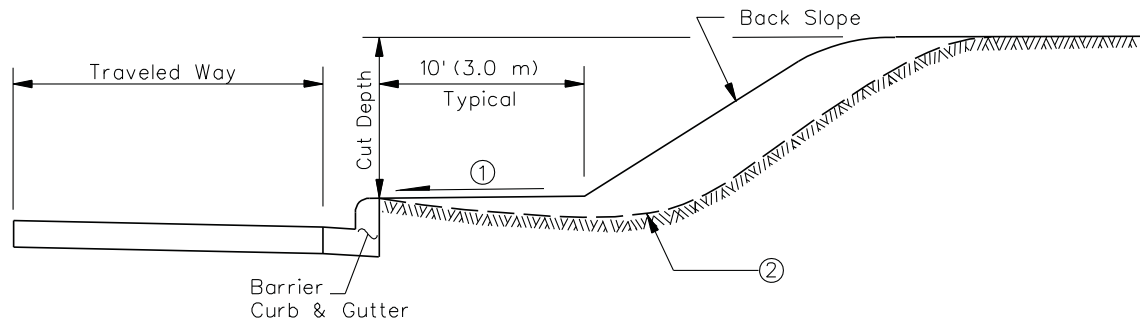

Notes:

- ① 2% If sidewalks are present or anticipated.  
5% If sidewalks are not present or anticipated.
- ② Drainage swale may be needed to meet field conditions.

Facility	Back Slopes (V:H)
Urban Arterials	1:3
Urban Marked Route Collectors	1:2

(A) DESIGN SPEED  $\leq$  45 mph (70 km/h)

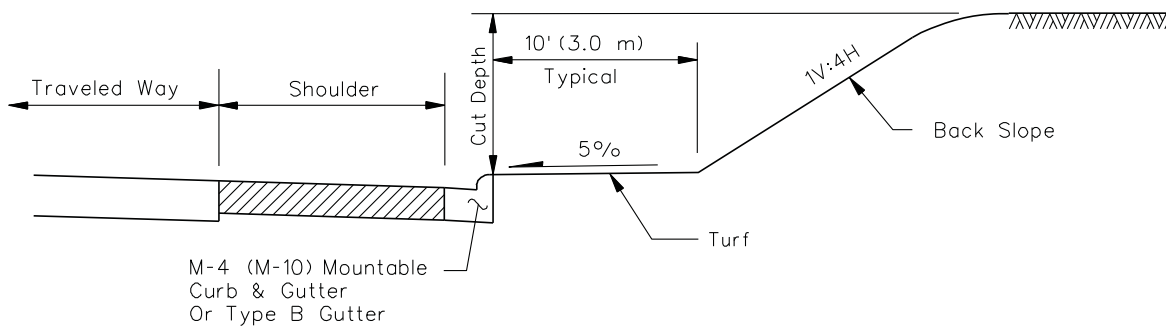

(B) DESIGN SPEED  $\geq$  50 mph (80 km/h)  
(RESTRICTED RIGHT-OF-WAY)

Note: See Section 38-3 for clear zone discussion.

**TYPICAL CUT SECTIONS  
(Curbed Facilities)**

**Figure 34-4D**

**Figure 32-3B (US Customary)**  
**ALIGNMENT CRITERIA FOR SUBURBAN/URBAN ARTERIALS**

Design Element	Manual Section	Design Speed							
		30 mph	35 mph	40 mph	45 mph	50 mph	55 mph	60 mph	
* Stopping Sight Distance	28-1	200'	250'	305'	360'	425'	495'	570'	
* Intersection Sight Distance (1)	28-3	335'	390'	445'	500'	555'	610'	665'	
* Minimum Radii	e <sub>max</sub> = 6% (open roadway)	29-2.03	275' (2)	380' (2)	510' (2)	660' (2)	835'	1065'	1340'
	e <sub>max</sub> = 4% (open roadway)	29-2.03	300'	420'	565'	730'	930'	1190'	1505'
	e <sub>max</sub> = 4% (low-speed)	29-4.03	230'	345'	490'	665'	—	—	—
* Maximum Superelevation Rate	29-3.01	4% (3)	4% (3)	4% (3)	4% (3)	6%	6%	6%	
Superelevation Transition Length	e <sub>max</sub> = 6% (4a) (open roadway)	29-3.02	136'	145'	155'	166'	180'	191'	200'
	e <sub>max</sub> = 4% (4b) (open roadway)	29-3.02	92'	98'	104'	112'	121'	129'	135'
	e <sub>max</sub> = 4% (4b) (low-speed)	29-4.04	75'	80'	84'	91'	—	—	—
* Vertical Curvature (K-values based)	Crest	30-2.01	19	29	44	61	84	114	151
	Sag	30-2.02	37	49	64	79	96	115	136
* Maximum Grade	Level	30-1.02	8%	7%	7%	6%	6%	5%	5%
	Rolling		9%	8%	8%	7%	7%	6%	6%
Minimum Grade	30-1.03	Desirable: 0.5% Minimum: 0.3% (with Curb and Gutter)							

\* Controlling design criteria (see Section 27-7).

- (1) Intersection Sight Distance. Table values are for passenger cars at a stop-controlled intersection on a level grade based on the design speed for the major road. Increase these distances 10% for grades > 3.0% on the minor road.
- (2) Minimum Radii. For urban streets with design speeds less than 50 mph, use e<sub>max</sub> = 4% (low speed).
- (3) Superelevation Rate. For urban/suburban reconstruction projects, existing horizontal curves may remain in place with a superelevation rate up to 6.0%.
- (4) Superelevation Transition Length. Superelevation transition rates will vary according to design speed, radii, and superelevation rates.
  - (a) Values are based on the minimum radii for the given design speed, maximum superelevation rate of 6.0%, 12 ft travel lanes, and a 1.5% cross slope for the normal crown section.
  - (b) Values are based on the minimum radii for the given design speed, maximum superelevation rate of 4.0%, 11 ft travel lanes, and a 1.5% cross slope for the normal crown section.

1. Basic Approach. The best approach to laying grade and balancing earthwork is to provide a significant length of roadway in embankment and to limit the number and amount of excavation areas. As practical, avoid long lengths of roadway in excavation and several short balance distances. Use topographic mapping to layout profile gradelines.
2. Urban/Rural. Earthwork balance is typically a practical objective only in rural areas. In urban areas, other project objectives (e.g., limiting right-of-way impacts) typically have a higher priority than balancing earthwork. In addition, excavated materials from urban projects are often unsuitable for embankments (e.g., near gas stations).
3. Borrow Sites. The availability and quality of borrow sites in the vicinity of the project will impact the desirability of balancing the earthwork. Triangular shaped remainders or landlocked right-of-way parcels usually provide potential locations for borrow sites.
4. Earthwork Computations. On large projects (e.g., freeways or expressways, bypasses, horizontal curve relocations) preliminary earthwork is calculated during Phase I using topographic mapping and is later refined during the preparation of construction plans. Section 64-2 discusses the proper methods to compute and record the project earthwork quantities.

### **33-6.04(h) Bridges**

Carefully coordinate the design of the profile gradeline with any bridges within the project limits. The following will apply:

1. Vertical Clearances. The criteria in Chapters 44 through 50 must be met. When laying the preliminary grade line, an important element in determining the available vertical clearance is the assumed structure depth. This will be based on the structure type, span lengths, and depth/span ratio. For preliminary designs, see the *Bridge Manual* and Chapter 39. For final design, the designer must coordinate with the Bureau of Bridges and Structures to determine the roadway and bridge gradelines. This is typically accomplished with a Type, Size, and Location (TS&L) Drawing.
2. Bridges Over Waterways. Where a proposed facility will cross a body of water, the bridge elevation must be consistent with the necessary waterway opening to meet the Department's hydraulic requirements. The elevation of the bottom of the superstructure must meet the requirements of Chapter 39. The designer must coordinate with the Hydraulics Unit in the Bureau of Bridges and Structures to determine the appropriate bridge elevation. In addition, where a bridge over a waterway is located in a sag curve, desirably, locate the low point of the sag vertical curve off the bridge deck, and provide at least a 0.5% grade on the bridge deck.

3. Railroad Bridges. Any proposed highway over a railroad must meet the applicable criteria (e.g., vertical clearances, structure type and depth). For rural freeways and expressways over railroads, the approach grades are usually set at 3%. Use the K-value, as discussed in Section 33-4.01, for the crest vertical curve. Use a long sag vertical curve at the bottom of each 3% grade to provide a smooth and aesthetically pleasing profile. In addition, if the alignment of the highway over the railroad will have a horizontal curve near the crest of the vertical curve, do not place the P.C. of the horizontal curve any closer than 400 ft (120 m) from the back of the bridge abutment. This guideline will ensure proper sight distance to the beginning of the horizontal curve.
4. Highway Under Bridge. Where practical, the low point of a roadway sag vertical curve should not be within the shadow of the bridge. This will help minimize ice accumulations, and it will reduce the ponding of water beneath the bridge. To achieve these objectives, the low point of a roadway sag should be approximately 100 ft (30 m) or more from the side of the bridge.
5. High Embankments. Consider the impact that high embankments will have on bridges and culverts. High embankments will increase the span length thus increasing structure costs, and also increase the length and type of culvert to carry the overburden.
6. Bridges Over Another Highway. Typically, the overpassing bridge will be located on a crest vertical curve. For bridges on crossroads through an interchange, use the desirable K-value for the crest vertical curve. For other bridges, the use of minimum K-values is acceptable.

#### **33-6.04(i) At-Grade Railroad Crossings**

The profile gradeline should be essentially level across the railroad tracks and extend level for a minimum distance of 2 ft (600 mm) on either side of the outermost rails. After this point, the grade should not exceed  $\pm 1\%$  for a distance of at least 26 ft (8 m) or to the railroad right-of-way line. Profile gradelines outside of the railroad right-of-way but within the jurisdiction of the Illinois Commerce Commission should be as flat as practical and should not exceed 5%. Where superelevated tracks make strict compliance with this criteria impractical, construct the grade of the approaches to provide the best (smoothest) profile practical.

#### **33-6.04(j) Distance Between Vertical Curves**

A desirable objective on rural facilities is to provide at least 1500 ft (500 m) between two successive VPI's. This objective only applies to projects which have a considerable length and where implementation is judged to be practical.

**BUREAU OF LOCAL ROADS & STREETS**

Jan 2006

**VERTICAL ALIGNMENT**

30-2(9)

3. Minimum Length. For most sag vertical curves, the minimum length of curve should also be based on the following equations:

$$L_{\min} = 3 V \quad (\text{US Customary}) \text{ Equation 30-2.3}$$

$$L_{\min} = 0.6 V \quad (\text{Metric}) \text{ Equation 30-2.3}$$

Where:

$L_{\min}$  = minimum length of vertical curve, ft (m)

$V$  = design speed, mph (km/h)

4. Comfort Criteria. On fully lighted, continuous sections of highway and where it is impractical to provide stopping sight distance for headlights, a sag vertical curve may be designed to meet the comfort criteria. The length of curve equation for the comfort criteria is:

$$L = \frac{AV^2}{46.5} \quad (\text{US Customary}) \text{ Equation 30-2.5}$$

$$L = \frac{AV^2}{395} \quad (\text{Metric}) \text{ Equation 30-2.5}$$

Where:

$L$  = length of vertical curve, ft (m)

$A$  = algebraic difference between the two tangent grades, %

$V$  = design speed, mph (km/h)

5. Drainage. Proper drainage must be considered in the design of sag vertical curves on curbed sections and bridges. Drainage problems are minimized if the sag vertical curve is sharp enough so that a minimum longitudinal grade of at least 0.3% is reached at a point about 50 ft (15 m) from either side of the low point. To ensure that this objective is achieved, base the length of the vertical curve upon a K-value of 167 (51) or less. This K-value is adequate for design speeds of 60 mph (100 km/h) or less.

For uncurbed sections of highway, drainage should not be a problem at sag vertical curves.

Classification		Suburban Arterial			Urban Two-Way Arterial			Urban One-Way Arterial		
Highway Type		TWS-2	TWS-4	TWS-6	TWS-2	TWS-4	TWS-6	OWS-2	OWS-3	OWS-4
Approach Roadway Criteria		See Figure 32-2C			See Figure 32-2D			See Figure 32-2E		
Design Traffic Volumes		Two-Way DHV <sup>(2)</sup>						One-Way DHV <sup>(2)</sup>		
		< 1250	1250-2050	2050-2900	< 1250	1250-2050	2050-2900	< 1300	1300-1850	> 1850
Clear Roadway Bridge Widths (Face-to-face of Parapets or Curbs) <sup>(3)(4)</sup>		Approach Surface Width			Approach Roadway Width (but not less than existing roadway width) or Face-to-Face of Curb as Specified in Chapter 32					
Minimum Width of Bridges (Face-to-Face of Parapets or Curbs) Allowed to Remain in Place <sup>(5)</sup>		Traveled Way + 2' Each Side for Rural Approach Cross Sections Width of Approach Roadway (face-to-face of curb) for Urban Approach Cross Sections								
Minimum Design Flood Frequency		30 year								
Minimum Clearance Above Design High-Water Elevation <sup>(6)</sup>		1'								
Design Live Load	New	HS-20								
	Remain in Place <sup>(8)</sup>	HS-15								
Vertical Clearance for Structures Over Highways <sup>(7)</sup>	New	See Figure 36-4I								
	Remain in Place	14'								
Horizontal Clearance for Structures Over Highways		See Figure 36-4I or 1.5' Behind Face of Curb								
Vertical Clearance for Pedestrian or Bicycle Structures Over Highways		17'-3"								
Vertical and Horizontal Clearance for Structures Over Railroads		See Figures 36-4J and 36-4K								

TWS = Two-Way Street      OWS = One-Way Street

**DESIGN CRITERIA FOR NEW OR RECONSTRUCTED<sup>(1)</sup> SUBURBAN/URBAN ARTERIAL BRIDGES**  
**Figure 36-5B (US Customary)**



**Footnotes for Figure 36-5B**

- (1) *Implies reconstruction of a significant length of existing highway either on new location or within existing right-of-way. For reconstruction of relatively short intermittent highway segments within a project, the design criteria used, where cost-safety effective, should be consistent with the adjacent highway design but not less than that allowed to remain in place.*
- (2) *The design hourly volumes (DHV) are calculated using a peak hour factor (PHF) = 1.0; adjust these values using local peak-hour factors.*
- (3) *Bridge widths for bridge rehabilitation projects are discussed in Chapter 33.*
- (4) *For urban bridges requiring sidewalks, the width of the sidewalks is 5 ft (1.5 m) unless a wider width is specified by the local agency.*
- (5) *Bridges remaining in place without a design exception approval when a safety record is satisfactory if the bridge is being gapped within a roadway section. Clear width between curbs or rails, whichever is less, should be equal to or greater than the approach traveled way width.*
- (6) *For reconstruction projects, the proposed low superstructure should not be below the existing superstructure unless 1 ft (300 mm) of clearance above design high water is achieved. Any proposed clearance less than 1 ft (300 mm) above design high water elevation must be accompanied by a request for a design exception.*
- (7) *The minimum required vertical clearance must be available over the traveled way and any paved shoulders.*
- (8) *The design live load for bridges to remain in place only applies to minor rehabilitation and in-kind replacements (e.g. rail or joint repair, partial deck repair, individual stringer replacement, etc.). Other work, including deck replacement shall be considered new.*

*Note: Traveled way width is the sum of the widths of all travel lanes. It is the larger of the value from Chapter 32 or, for existing bridges, the existing (or proposed) width of the approach traveled way.*

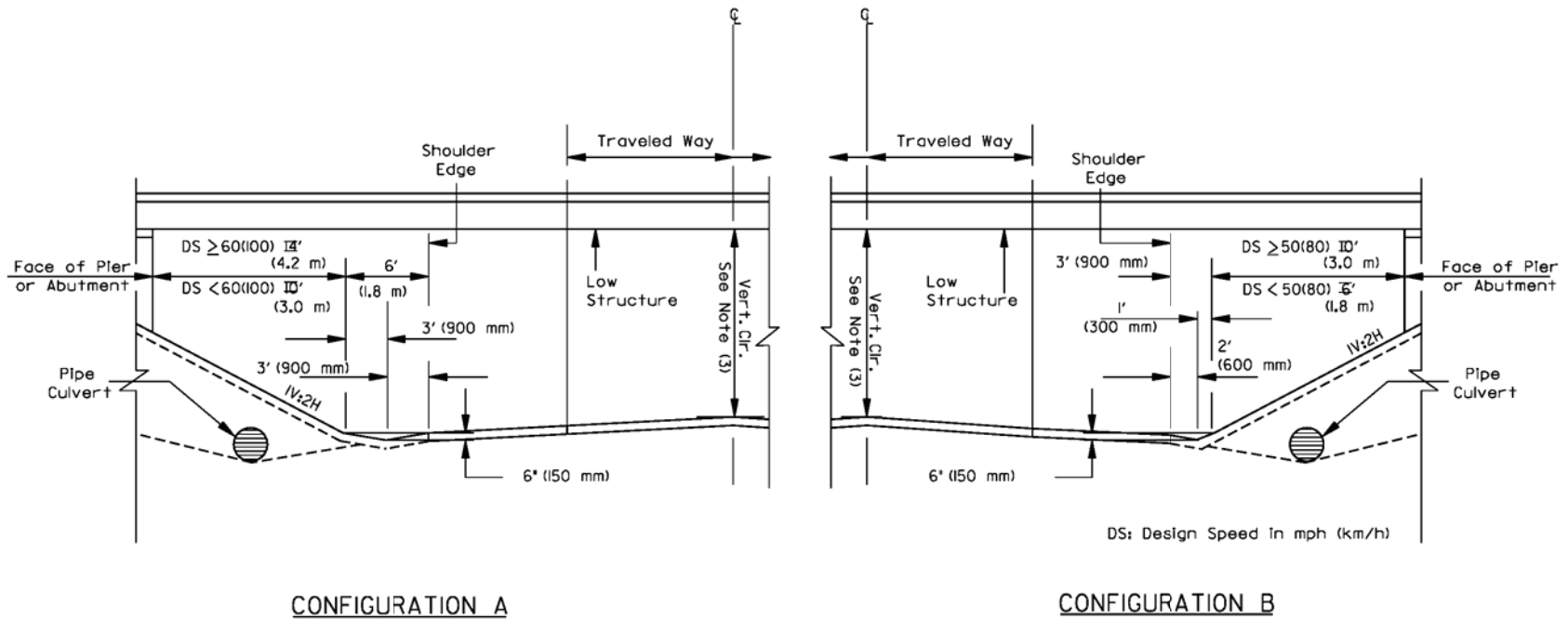

CONFIGURATION A

CONFIGURATION B

Functional Classification of Underpassing Highway	Current ADT or 20-Year DHV	Configuration	Minimum Vertical Clearance
Rural Arterial (New)	All ADTs	A	16'-6" (5.0 m)
Rural Arterial (Reconstruction)	All ADTs	A	16'-3" (4.9 m)
Urban Arterial	All ADTs	A	14'-9" (4.5 m)
Local Road or Collector	DHV > 200	A	14'-9" (4.5 m)
Local Road or Collector	DHV ≤ 200	B	14'-9" (4.5 m)
Local Road or Collector	ADT ≤ 400	B	14'-9" (4.5 m)

Notes:

1. Locate the upstream traffic end of a through pipe culvert outside the clear zone of the near edge of traveled way.
2. All horizontal dimensions are right-angle dimensions.
3. Locate the minimum clearance point at the least clearance point above the usable roadway under, including stabilized shoulders.

CLEARANCES FOR BRIDGES OVER TWO-LANE ROADS

Figure 36-4I

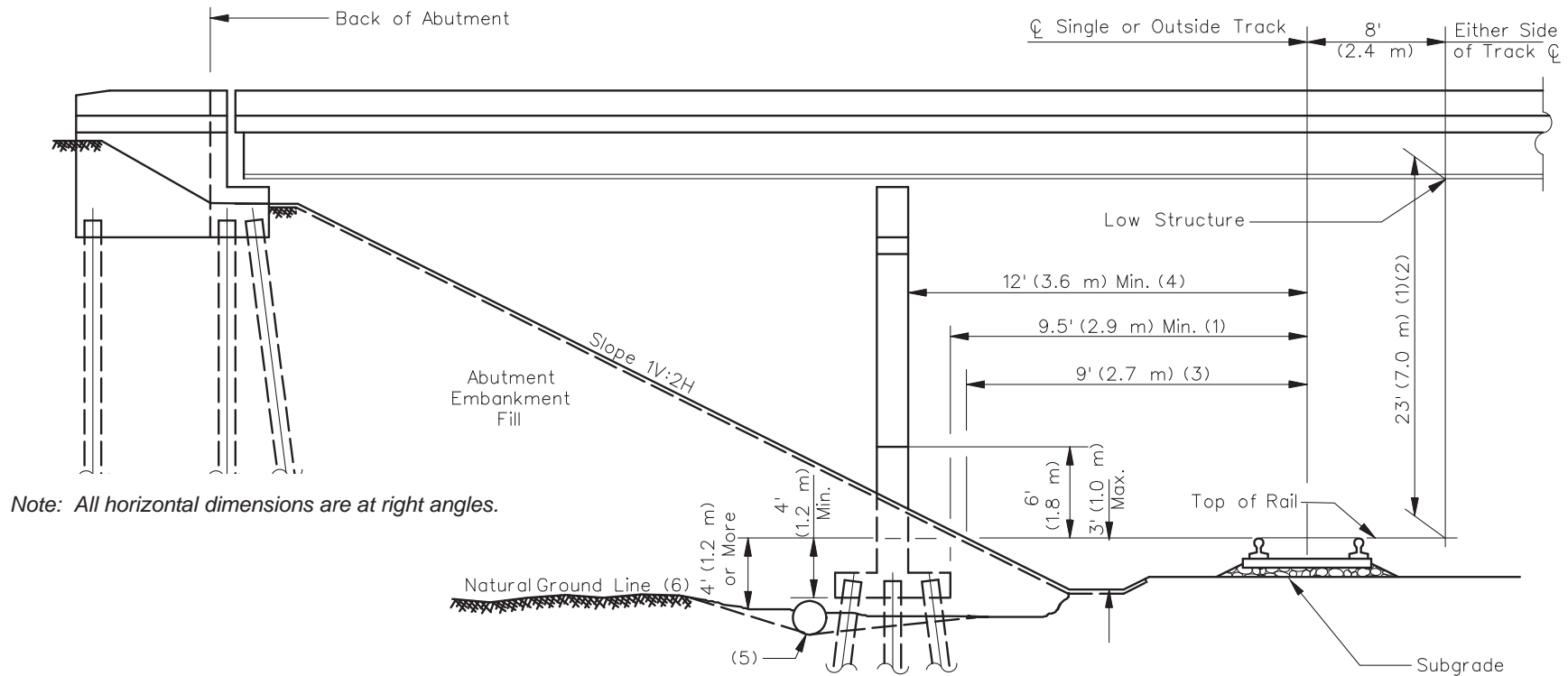

## Notes:

1. Do not reduce without consent of the Railroad Company.
2. A vertical clearance of not less than 23 ft (7.0 m) above the top of rail shall be provided for all new or reconstructed highway bridges constructed over a railroad track. The Illinois Commerce Commission may permit a lesser clearance if it determines that the 23 ft (7.0 m) clearance standard cannot be justified based on engineering, operational, and economical conditions.
3. This dimension may be increased by up to 8 ft (2.4 m) on one side only, as may be necessary for off-track maintenance equipment when justified by the Railroad Company.
4. Locate piers or columns so as not to encroach on drainage ditches.
5. Intercepted drainage along railroad embankment shall be accommodated with a minimum 3 ft (900 mm) diameter culvert or carried along highway embankment.
6. Where natural ground is less than 4 ft (1.2 m) below top of rail, see Figure 36-4J.

**HIGHWAY GRADE SEPARATION OVER RAILROAD  
(Natural Ground 4 ft (1.2 m) or More Below Rail)**

**Figure 36-4K**

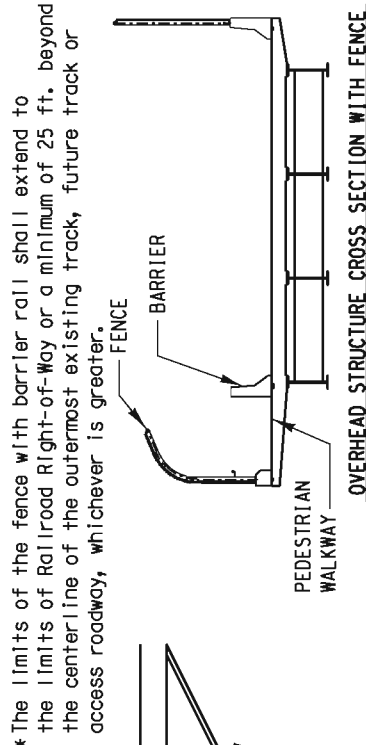

NOTE: WIDTH AND HEIGHT SUBJECT TO HYDRAULIC REQUIREMENTS. SEE PLAN NO. 711100, SHEET 5.

**ELEVATION**  
PERPENDICULAR TO TRACKS

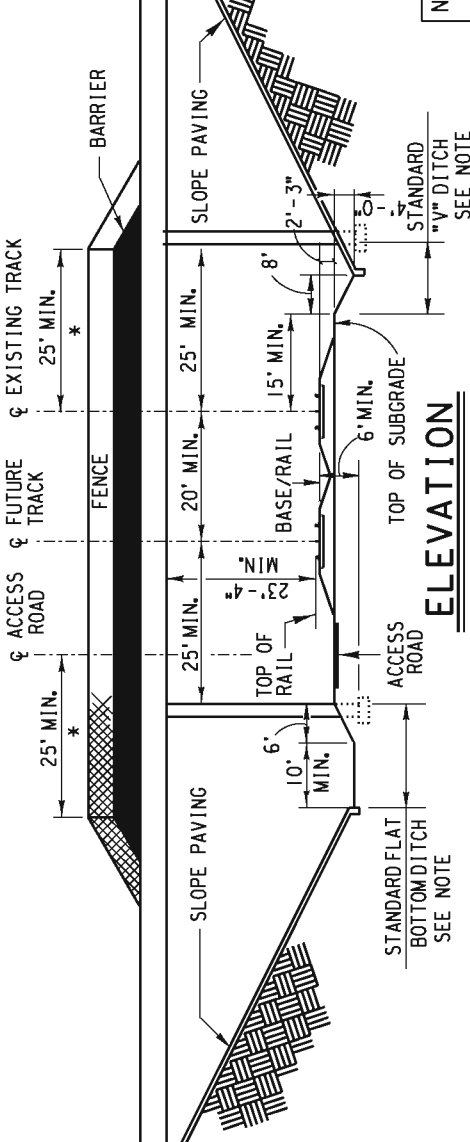

**GENERAL**  
Fence shall be provided as indicated on the cross sections and elevation view on both sides of the Overhead Structure in ALL new or modified structures.  
Barrier rail for Overhead Structures, without walkways, that may be subject to snow removal shall be a minimum of 42 inches in height with a 4 foot wide shoulder or 30 inches in height with a 6 foot wide shoulder. See Plan No. 711100, Sheet 4.  
Lights are to be installed on the underside of the Overhead Structure where shadows cast by the structure would interfere with Railroad operations.  
Slope paving shall be provided where end slopes are equal to or exceed 2 horizontal to 1 vertical.  
Falsework for construction of overhead structures shall comply with Railroad Requirements.  
Demolition of existing Overhead Structures shall comply with Railroad Demolition Requirements. Temporary shoring shall be designed in accordance with Railroad Guidelines for Temporary Shoring.  
Applicant shall be responsible for identification, location and protection of existing utilities.  
Call the following numbers at least 48 hours prior to commencing work to determine location of fiber optics:  
UPRR "Call Before You Dig", 1-800-336-9193  
BNSF "Call Before You Dig", 1-800-533-2891.

**CLEARANCES**  
Minimum vertical clearance shall be 23'-4" above the top of high rail within 25' of centerline of track. Additional clearance may be required for construction purposes or if sag of vertical curve must be adjusted or if future track raise for flood considerations or maintenance is probable.  
Minimum horizontal clearances, measured at right angle from centerline of track, shall be as shown in elevation view. For minimum construction clearances, see Plan No. 711100, Sheet 3.

**PIERS**  
Piers shall be located outside Railroad Right-of-Way.  
Pier protection walls shall be provided in accordance with AREMA Chapter 8, Part 2.1.5 for piers within 25 feet of the centerline of track.  
Top of footings located within 25 feet from centerline of track shall be a minimum of 6 feet below base of rail and a minimum of 1 foot below flowline of ditch.

**DRAINAGE**  
Drainage from the Overhead Structure shall be diverted away from and not discharged onto the tracks, roadbed and Railroad Right-of-Way.  
At minimum, a standard "V"-shaped or flat-bottom ditch shall be provided on each side of the tracks as necessary.  
Culverts may be installed in lieu of standard Railroad ditches when approved by Railroad Central Engineering. Maintenance of culverts will be at Applicant's expense.

**FUTURE TRACKS AND ACCESS ROAD**  
Space is to be provided for one or more future tracks as required for long range planning or other operating requirements. Where provision is made for more than two tracks, space is to be provided for an access road on both sides of tracks.

**REVISIONS**

DATE	LTR.	DESCRIPTION
/	/	/
/	/	/
/	/	/
/	/	/
/	/	/

\* The limits of the fence with barrier rail shall extend to the limits of Railroad Right-of-Way or a minimum of 25 ft. beyond the centerline of the outermost existing track, future track or access roadway, whichever is greater.



FILE NAME: P:\station\dm\std\pp\guidelines.dgn

UNION PACIFIC RAILWAY

**BRIDGE STANDARDS**  
GRADE SEPARATION GUIDELINES (OVERHEADS)  
**GENERAL OVERHEAD STRUCTURE DRAWING**

DESIGN BY: RAF    DRAWN BY: KDM    CHECKED BY: KHJ  
APPROVED: *K.H. Jernison*  
BNSF - ASSISTANT DIRECTOR STRUCTURES DESIGN  
*Allyce J. Meyrn*

UPRR - M&M SPECIAL PROJECTS STRUCTURES DESIGN

FILE OWNER: UPRR    DATE: 1/24/07  
PLAN NO.: 711100    SHEET: 1

PLotted: 3/30/2007 2:53:46 PM

construction.” All discrepancies shall be brought to the attention of the Railroad prior to the commencement of construction.

### 5.2.2 Permanent Horizontal Clearance

Future Track per [Section 4.1.3](#) and Access Road per [Section 4.1.4](#), of these Guidelines must be verified with the Railroad in advance of establishing horizontal clearances. The Railroad requires all piers and abutments to be located outside the Railroad right-of-way limits and to comply with [Section 4.1.3](#) and [4.1.4](#) of these Guidelines. If this is not feasible, all piers and abutments shall be located more than 25 feet measured perpendicular from centerline of nearest existing or future track. Piers within 25 feet, measured perpendicular from centerline of existing or future track, shall be protected per [Section 5.5.2](#) of these guidelines. Absolute minimum horizontal clearance requiring special review and approval by the Railroad, and subject to site conditions, shall be 18 feet measured perpendicular from the centerline of the track to the face of the pier protection wall.

### 5.3 Temporary Clearances

The proposed Overhead Structure shall be designed to satisfy temporary construction clearance requirements per [Section 4.4.1](#) and shown on the plans in accordance with Figure 1 on [Plan No. 711100, sheet 3](#).

### 5.4 Overhead Superstructures

The use of cast-in-place beams is not permitted. The use of stay in place deck forms for falsework between precast concrete beams or steel girders is encouraged.

#### 5.4.1 Barrier Rail

Cast-in-place concrete barrier rail without openings and a minimum height of 30 inches shall be provided on both sides of the superstructure to retain and redirect errant vehicles. The barrier rail shall keep the deck's storm runoff from being deposited onto Railroad right-of-way.

Barrier rail for Overhead Structures, which may be subject to snow removal, shall be a minimum of 42 inches in height with a 4 foot wide shoulder, or 30 inches in height with a 6 foot wide shoulder.

Limits of the barrier rail shall extend to the limits of the Railroad right-of-way or a minimum of 25 feet beyond the centerline of the outermost existing track, future track or Access Road, whichever is greater.

The barrier rail shall be detailed in accordance with [Plan No. 711100, sheet 4](#).

#### 5.4.2 Fence with Barrier Rail

Fence with barrier rail shall be provided on both sides of all Overhead Structures crossing Railroad right-of-way. It shall be designed to prevent climbing and provide positive means of protecting the Railroad facility and the safety of Railroad employees below from objects being thrown by pedestrians or passing motorists.

The limits of the fence with barrier rail shall extend to the limits of the Railroad right-of-way or a minimum of 25 feet beyond the centerline of the outermost existing track, future track or Access Road, whichever is greater. All parallel Overhead Structures that have a gap of 2 feet or more shall be protected with fencing. Structures with a gap of 2 feet or less shall either have the gap covered or be fenced on both sides.

The minimum combined height of a barrier rail with curved fence shall be 8 feet or with a straight fence shall be 10 feet. The barrier rail with fence detail shall be in accordance with [Plan No. 711100, sheet 4](#).

**NEW CONSTRUCTION**

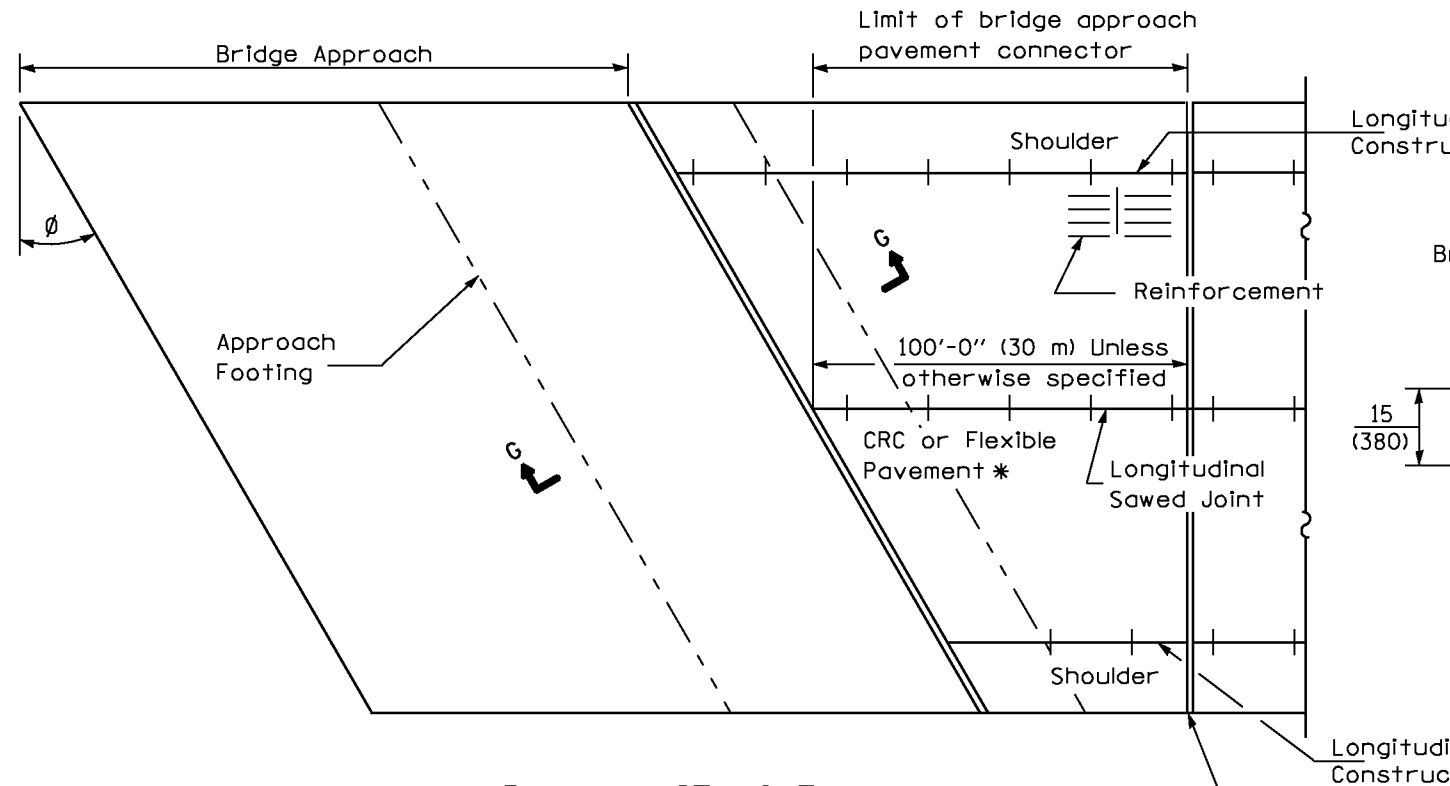

**PLAN - WITH SKEW**

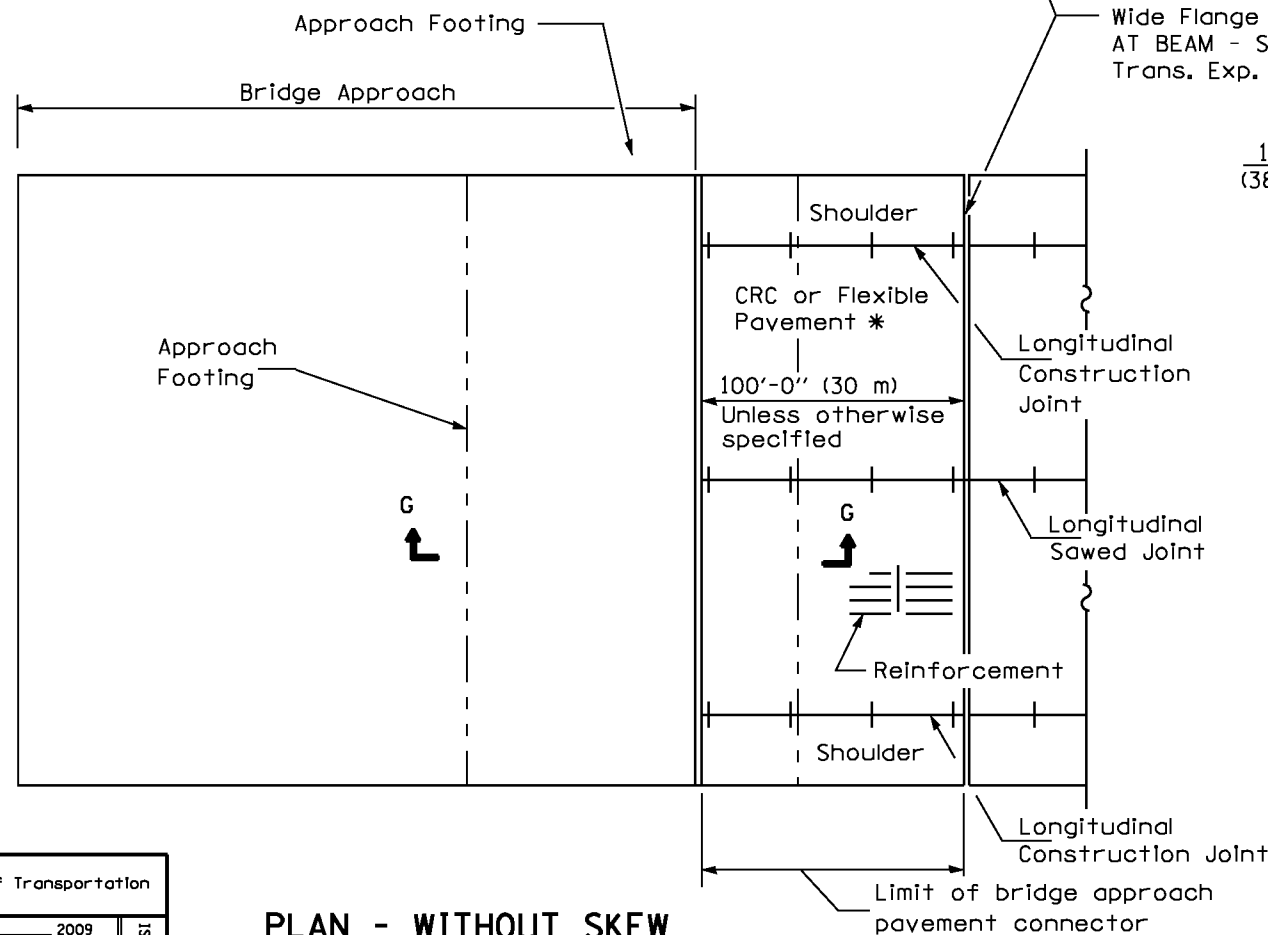

**PLAN - WITHOUT SKEW**

\* Omit Reinforcement, tie bars and Long. sawed Jt. for Flexible Pavement.

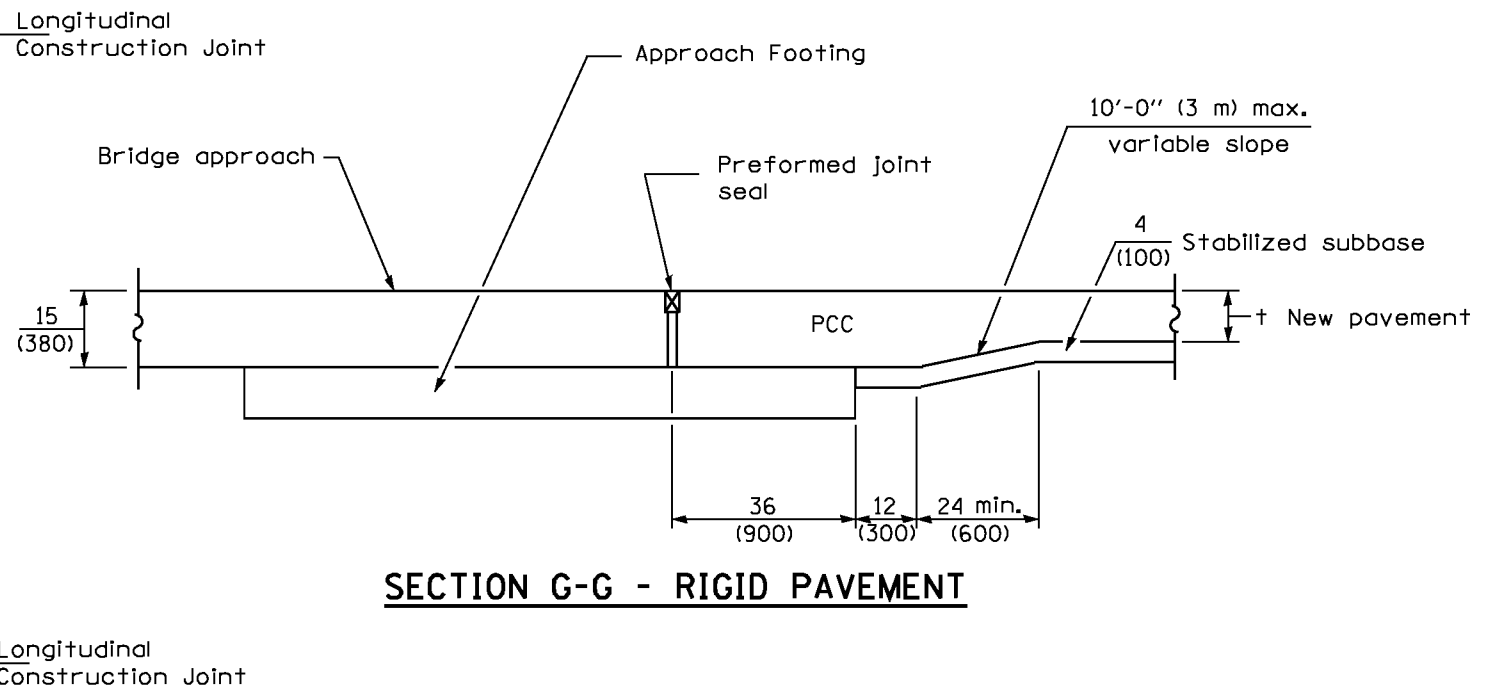

**SECTION G-G - RIGID PAVEMENT**

Rigid Pavement only:

Wide Flange Beam Terminal Joint (See DETAIL AT BEAM - Standard 421101 or 421106) or 2 (50) Trans. Exp. Joint as detailed on Standard 420001.

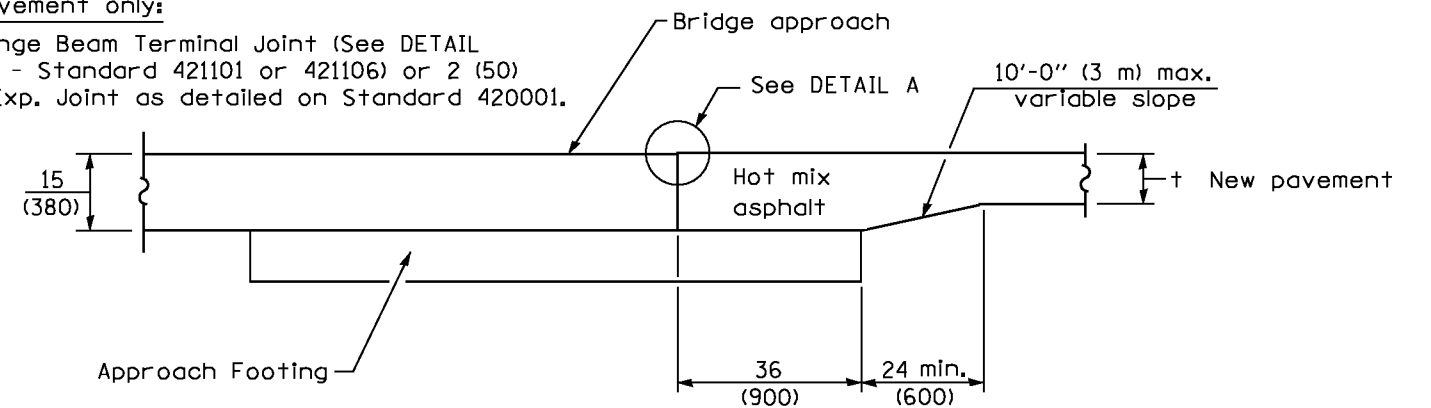

**SECTION G-G - FLEXIBLE PAVEMENT**

**GENERAL NOTES**

- THICKNESS--"t"=Thickness of Pavement.
- See Standard 421001 for reinforcement details not shown.
- See Standard 420001 for joint details not shown.
- See plans for details of bridge approach, approach footing and preformed joint seal.
- All dimensions are in inches (millimeters) unless otherwise shown.

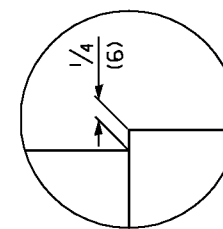

**DETAIL A**

DATE	REVISIONS
1-1-09	Completely revised std.
	Moved reinf. and details to base sheet.
1-1-08	Switched units to English (metric). Moved rebar epoxy coat note to Standard Spec.

**BRIDGE APPROACH PAVEMENT CONNECTOR**

(Sheet 1 of 2)

**STANDARD 420401-07**

Illinois Department of Transportation

APPROVED January 1, 2009  
*Scott Smith*  
 ENGINEER OF POLICY AND PROCEDURES

APPROVED January 1, 2009  
*Ken E. Han*  
 ENGINEER OF DESIGN AND ENVIRONMENT

ISSUED 1-1-97

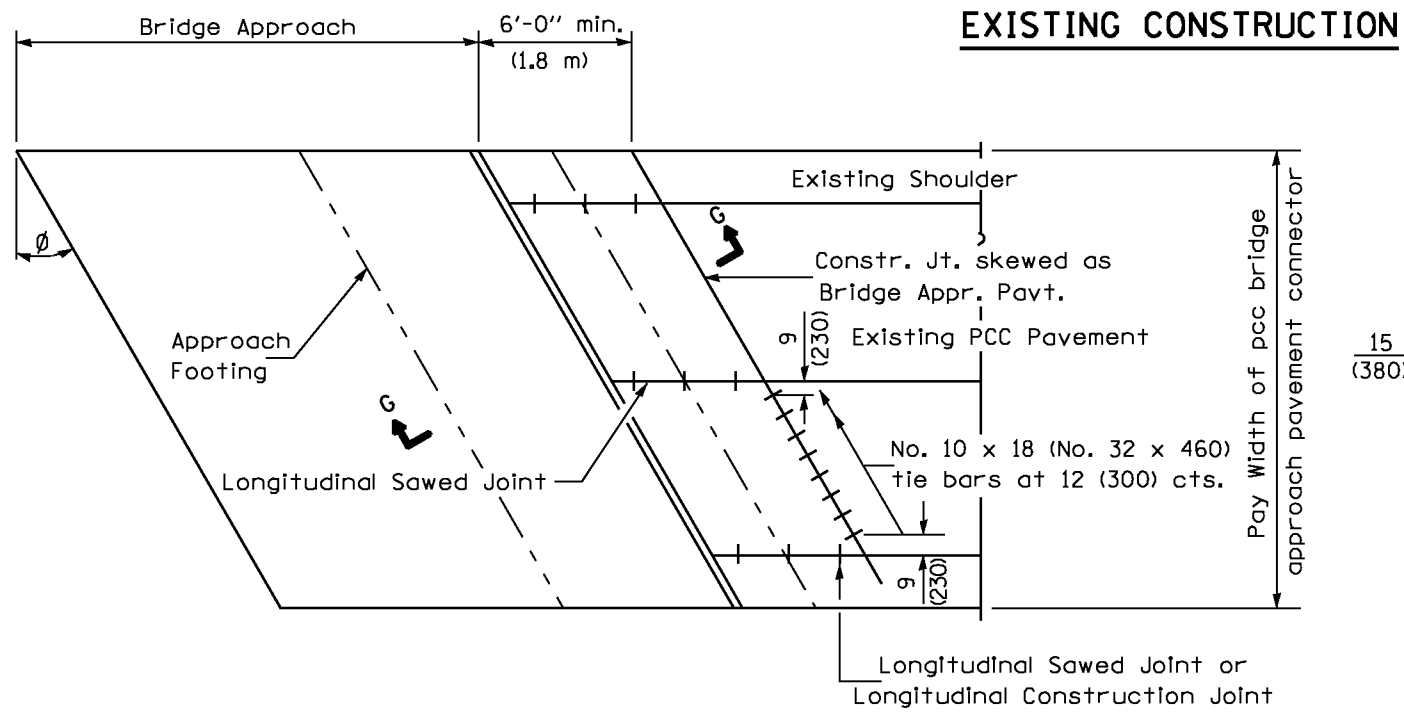

**BRIDGE APPROACH PAVEMENT CONNECTOR (PCC)**

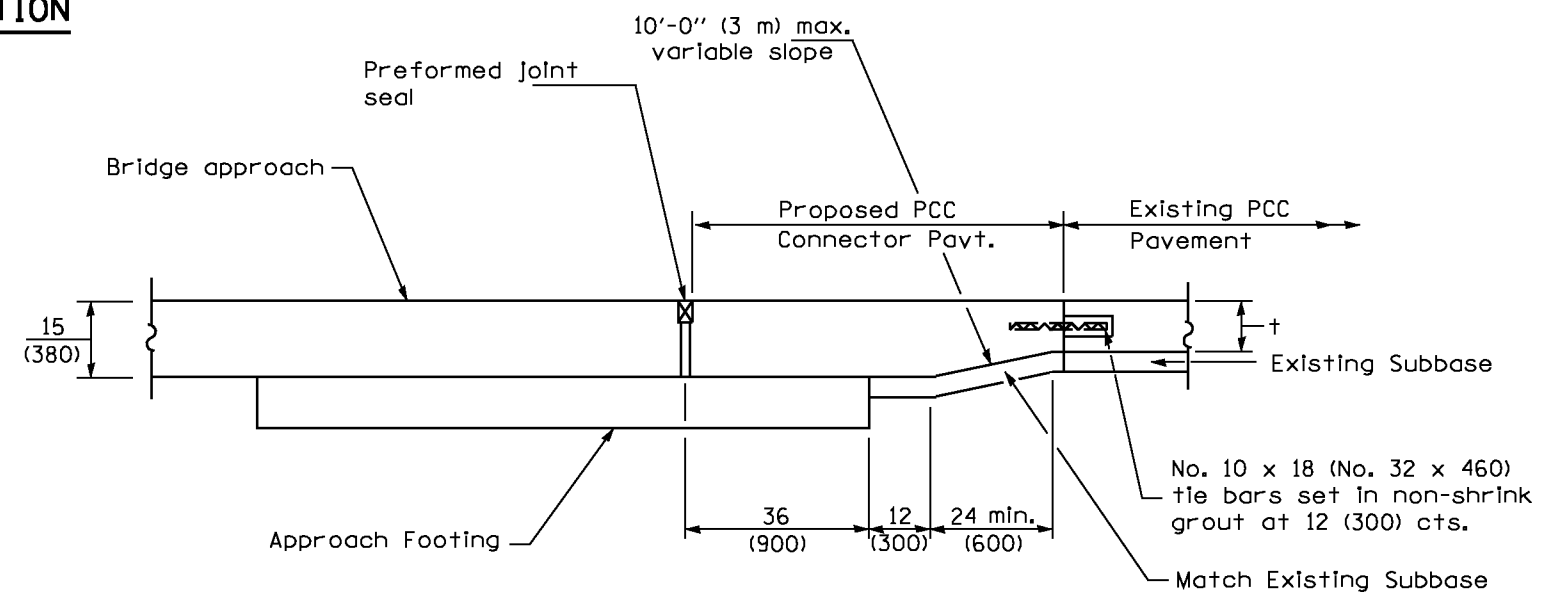

**SECTION G-G - RIGID PAVEMENT**

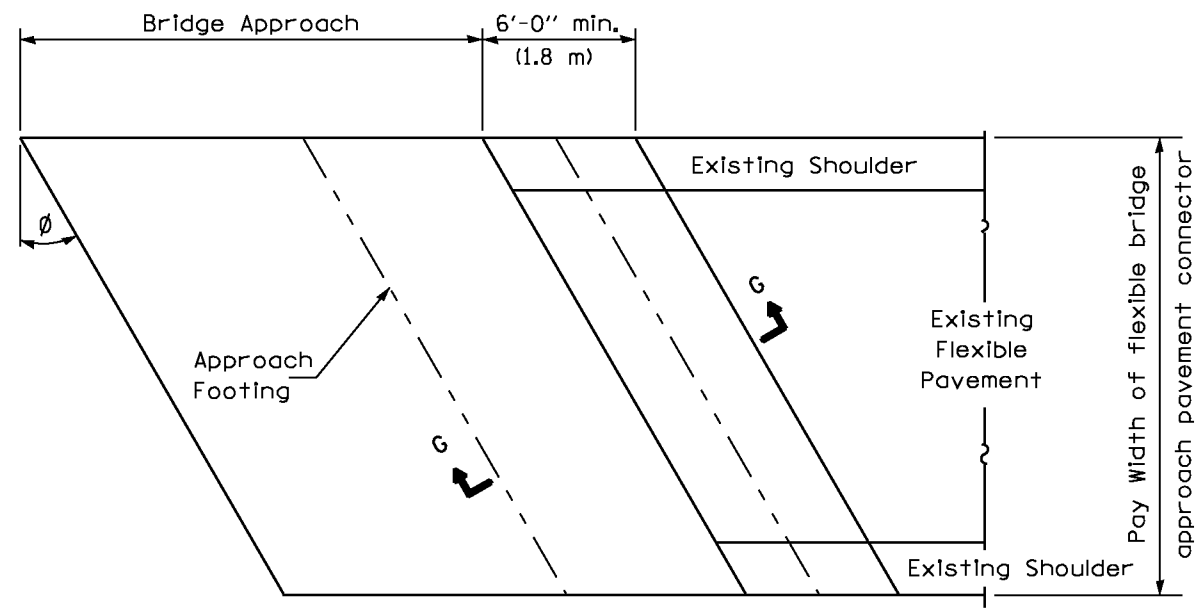

**BRIDGE APPROACH PAVEMENT CONNECTOR (FLEXIBLE)**

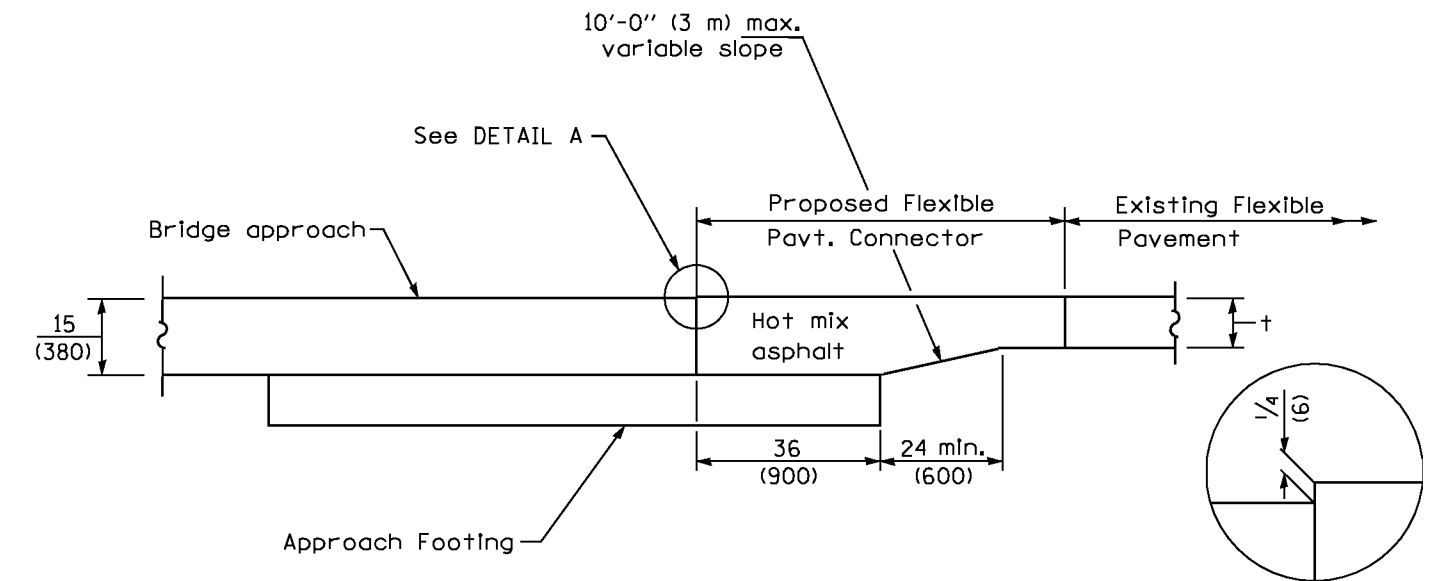

**SECTION G-G - FLEXIBLE PAVEMENT**

**DETAIL A**

Illinois Department of Transportation  
 APPROVED January 1, 2009  
 ENGINEER OF POLICY AND PROCEDURES  
 APPROVED January 1, 2009  
 ENGINEER OF DESIGN AND ENVIRONMENT

**BRIDGE APPROACH PAVEMENT CONNECTOR**  
 (Sheet 2 of 2)  
**STANDARD 420401-07**

MATERIAL REQUIRED FOR 1000 FEET OF SINGLE TRACK	
BALLAST	SELECTED MATERIAL
DEPTH ABOVE TOP SUBGRADE	DEPTH ABOVE TOP SUBGRADE
SHOULDER YARDS	CUBIC YARDS
15"	625
12"	650
9"	925
12"	960
15"	1385

ABOVE QUANTITIES ARE FOR TANGENT TRACK AND INCLUDE 15% ALLOWANCE FOR SHRINKAGE.

10' WIDE BENCH SECTION TO BE PROVIDED AT EACH 20' INCREMENT OF HEIGHT ABOVE SUBGRADE

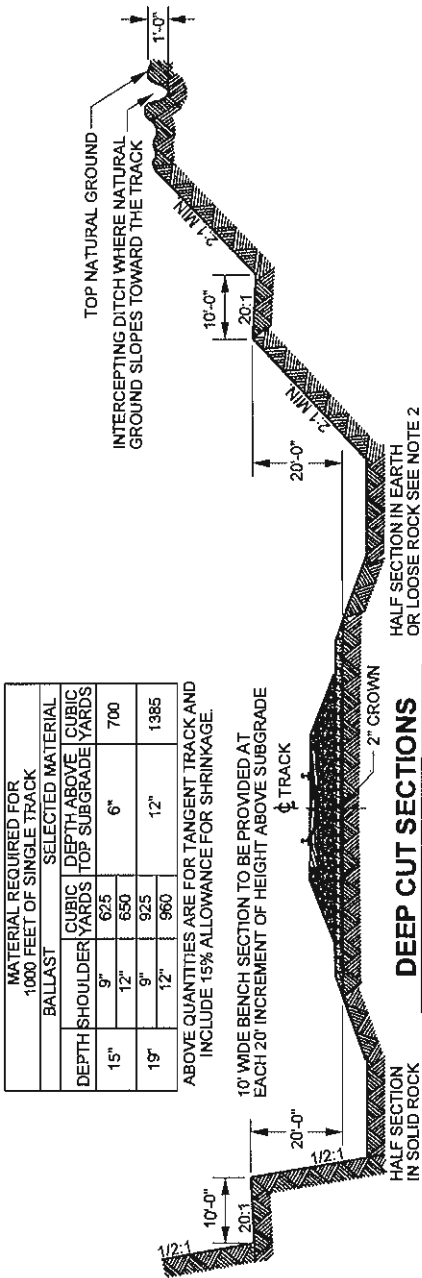

### DEEP CUT SECTIONS

HALF SECTION IN EARTH OR LOOSE ROCK SEE NOTE 2

HALF SECTION IN SOLID ROCK

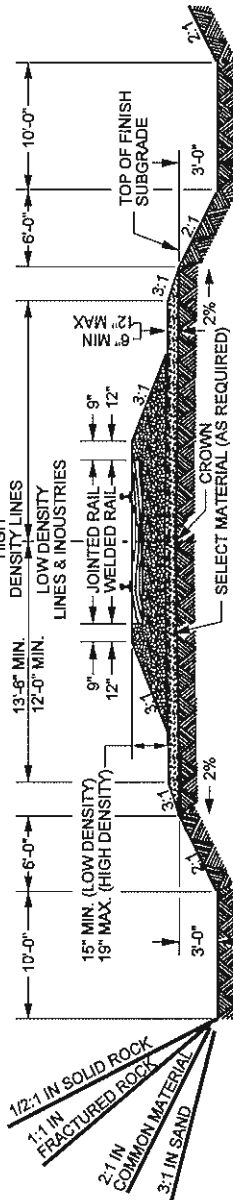

### ROADBED SECTIONS IN CUTS

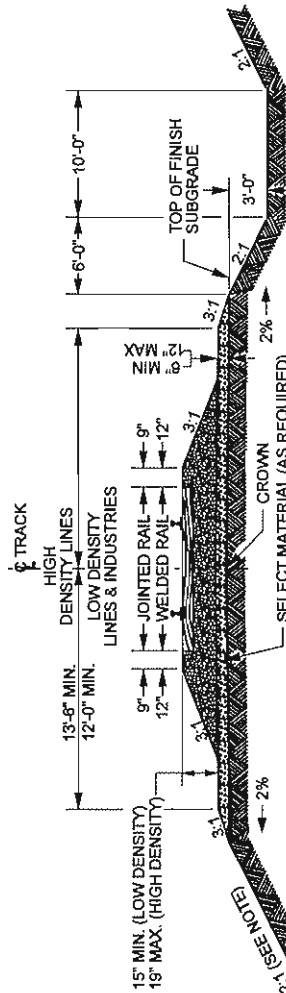

### ROADBED SECTIONS AT FILLS

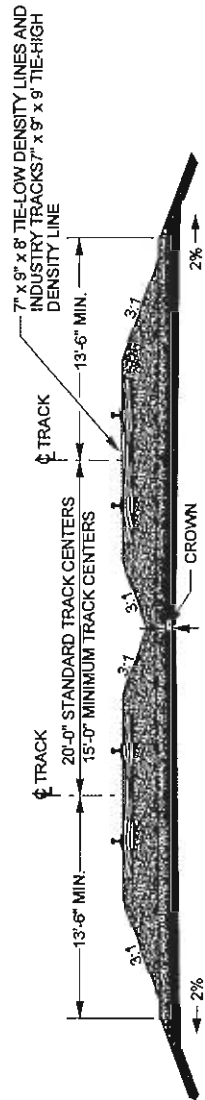

### BALLAST SECTION FOR TWO TRACKS

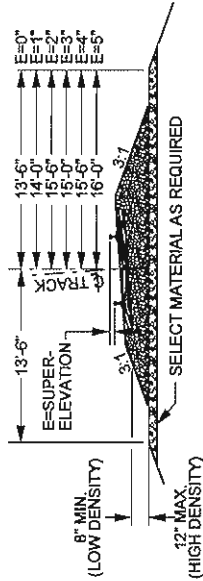

### ROADBED SECTION AT CURVED TRACK

FOR DETAILS NOT SHOWN, SEE CUT AND FILL SECTIONS ELSEWHERE ON THIS SHEET

#### NOTES:

- THE DEPTH OF BALLAST AND DEPTH OF SELECTED MATERIAL SHALL BE DECIDED ON THE BASIS OF VOLUME OF TRAFFIC AND THE QUALITY OF SELECTED MATERIAL AND SUBGRADE DETERMINED BY THE RAILROAD'S ENGINEER SUBJECT TO THE APPROVAL OF THE CHIEF ENGINEER.
- SLOPES SHOWN FOR BANKS IN CUTS AND ON FILLS SHALL BE CONSIDERED STANDARD AND GENERALLY USED, BUT MAY BE MODIFIED AS REQUIRED BY LOCAL CONDITIONS AND CHARACTER OF MATERIAL.
- BALLAST MUST BE EQUALIZED IN ADVANCE OF DRESSING SO THAT FINAL SECTION WILL CONFORM TO SLOPE REQUIREMENTS AND CHARACTER OF MATERIAL.
- WHERE OFF-TRACK ROADWAY IS TO BE PROVIDED, ADD 10'-0" ADDITIONAL WIDTH TO THE ROADBED SECTION AT TOP OF SELECTED MATERIAL ELEVATION.
- ALL FILL SLOPES SHALL BE FACED WITH COVER OF MATERIAL SUITABLE FOR GROWING GRASS AND HAVING A THICKNESS OF APPROXIMATELY 6 INCHES. THE OUTER SURFACE OF THIS COVER SHALL COINCIDE WITH THE DESIGN SLOPE OF THE EMBANKMENT. MATERIAL FOR THIS COVER MAY BE OBTAINED FROM STRIPPING.
- FLOW LINE ON 0.2% MINIMUM GRADE DITCHES AND BENCHES.
- FLAT BOTTOM DITCHES ARE REQUIRED FOR HIGH DENSITY LINES, HOWEVER A "V" DITCH IS ACCEPTABLE FOR INDUSTRY TRACKS WHEN RIGHT-OF-WAY IS LIMITED AND WHERE LOCAL CONDITIONS AND CHARACTER OF MATERIAL SO REQUIRE.
- REF U.P. STD DWG PAGE 0001.

## UNION PACIFIC RAILROAD ENGINEERING STANDARDS

# ROADBED SECTION FOR WOOD TIE TRACK CONSTRUCTION



ADOPTED: JAN. 21, 1927  
REVISED: SEPT 29, 2006  
FILE NO.: 0001B

STD DWG  
0001B

STD DWG  
0001B



## MILWAUKEE SUBDIVISION (152)

Mile Post	Rule 6.3	CP #’s	Radio Display: BJ East to Grand Avenue -2525		Sta. #’s	Siding Feet	
			SOUTH ▼ STATIONS ▲	NORTH ▲			
96.8	YL ABS	N097	BJ EAST (0.7)	T(M)	ED098		
96.1	YL DT	N096	BJ SOUTH (0.8)	(9)T(M) Y	EC097		
95.3			BUTLER (6.4)	(9)TY	EC096	Yard	
88.9			BELTON (4.6)	(9)TY	EC090		
84.3			MITCHELL (4.3)	(9)Y	EC085		
80.1		TWC ABS	N080	ST. FRANCIS (3.4)	(9)T(M) Y	EC081	
76.6			AIRPORT (11.1)	(9)	EC076		
65.5			KAY (13.8)		EC066	9915	
51.7			BAIN (13.5)	T	EC053	12672	
38.2			GURNEE (3.8)		EC039		
35.7			PARK CITY (3.8)		EC035		
31.9			UPTON (2.2)	(X)EJE(A)	EC033		
29.7	DT ABS			KO (8.1)		EC032	
21.2			N021	VALLEY (3.6)	(M)	EC021	
17.5				SHERMER (5.5)	X	EC018	
12.0		N012	DEVAL (1.1)	TX(9) (X)WC-UP(M)	EC012		
10.9		N011	NORMA (3.5)	TX(9)(M)	EC011		
7.4			BRYN MAWR (4.8)	X	EC006		
2.6			GRAND AVENUE	Y	EC004	Yard	

(93.7)

### SI-01 MAIN TRACK AUTHORITY

**BJ South to St. Francis - DT:** Trk 1 NWD and Trk 2 SWD.  
**St. Francis to KO:** TWC/ABS (DT St. Francis to Airport and Gurnee to Park City, Trk 1 NWD and Trk 2 SWD)  
**KO to Grand Ave. - DT:** Rule 9.14, Rule 9.15 KO to Bryn Mawr.  
**Yard Limits Between** MP 96.8 and MP 79.4; MP 7.2 and MP 2.6

### SI-02 MAXIMUM SPEED TABLE

Maximum Speed	MPH
<b>Between Mile Posts</b>	
96.8 and 76.6	
(Except as Below).....	40
96.1 Diverging .....	10
96.1 and 93.5 .....	30
88.9 and 88.5 .....	30
82.4 and 82.2 .....	25
80.7 Diverging .....	30
80.3 and 79.5 .....	30
79.5 and 76.6 Trk 2 .....	30
<b>Between Mile Posts</b>	
76.6 and 2.6	
(Except as Below).....	50
38.2 thru Turnout .....	30
35.7 thru Turnout .....	30
31.9 EJE (X) .....	30
29.7 thru Turnout .....	30
29.7 and 21.2 - Both Trks. ....	45
12.3 and 11.9 .....	30
10.9 Diverging .....	10

### SI-03 OTHER SPEED RESTRICTIONS

Maximum Speed	MPH
<b>1. Thru Sidings &amp; Turnouts</b>	
All Sidings.....	10
<b>2. Dual Control Switch Turnouts</b>	
CP N096.....	10
Except Milwaukee Sub Trk 1 to Adams Sub.....	30
<b>3. Misc. Speed Restrictions</b>	
Live wye (Normal to Seeger).....	10
Dead wye.....	5

### SI-04 MAIN TRACK DESIGNATIONS

**BJ South to St. Francis** DT Trk. 1 NWD and Trk. 2 SWD  
**St. Francis to Airport** DT Trk. 1 NWD and Trk. 2 SWD  
**Gurnee to Park City** DT Trk. 1 NWD and Trk. 2 SWD  
**KO to Grand Ave.** DT Trk. 1 NWD and Trk. 2 SWD

### SI-05 MILE POST EQUATIONS

MP 21.2 = MP 21.7

### SI-06 DTC BLOCK LIMITS - None.

### SI-07 ITEM 13 TRAIN DEFECT DETECTORS

(#)63.2  
 (#)44.2  
 (#)22.5

### SI-08 RULES ITEMS

**Rule 8.10** Spring switch indicators for spring switches at MP 93.2, MP 80.6 and MP 79.5.  
**Movement against the current of traffic** may be authorized by track permit or track bulletin.

### SI-09 FRA EXCEPTED TRACKS - None.

### SI-10 BUSINESS TRACKS

Track Name	MP	STA. #’S
West Allis .....	86.3	EC088
Waxdale .....	61.2	EC062
Pleasant Prarie .....	49.9	EC050
Blodgett .....	23.8	EC023
Elk Grove .....	7.8	EC007

**SI-11 INDUSTRIAL LEADS**

**Skokie Industrial Lead:** Extends from Valley 9.1 miles to Skokie, MP 12.6 Sta. No. SJ009. Intermediate station Northfield, Sta. No. SJ004. Six Axle Units Prohibited. FRA excepted track.

**Waukesha Industrial Lead:** Extends from Belton MP 9.8, 8.7 miles to MP 18.5. New Berlin Sta. No. EB005. FRA excepted track.

**SI-12 TONNAGE RESTRICTIONS - None.****SI-13 TRAIN MAKE-UP RESTRICTIONS - None.****SI-14 MISC. INSTRUCTIONS**

**Grand Avenue - Bryn Mawr:** Movements against the current of traffic protected by control operator at CP Tower B17 and Proviso General yardmaster under direction of the train dispatcher.

**Route Restrictions:** Cars in excess of 19 feet above top of rail are prohibited from operating between St. Francis and BJ. This includes loaded double stack cars, series TTQX (type M3X), BNSF 306000 - 306153, GVSR 89000 - 89058 must not be operated on the

**Proviso:** All trains arriving and departing Proviso must notify the train dispatcher of their arrival or departure time when passing Grand Avenue. Northward trains must not pass MP 5.0 until departure time has been given to the Control Operator at Deval.

**Bryn Mawr - Shermer:** (1) Before passing Bryn Mawr, northward trains will call control operator to ascertain when route is lined.  
(2) Control operator Bryn Mawr (B-17) will not permit northward CP trains to pass absolute signal without first ascertaining when route at Deval will be lined.

**Butler:** Northward trains must contact Butler Yardmaster for instructions before passing MP 90.8 (Potter Road). Engines 8500 thru 8700 are restricted from using crossover switches under Hampton Ave. enroute fueling station.

**Whistling Ordinances:** Ordinance prohibits the sounding of whistle within city limits of Des Plaines, Wauwatosa and West Allis. State law requires the sounding of engine whistle at Elmhurst Road, Elk Grove Lead to and from Milwaukee Subdivision and at Touhy Avenue MP 8.8, and Mt. Prospect Road MP 9.9.

**Six Axle Units Prohibited:** Norco - MP 3.0;  
Nestle Lead - MP 3.9;  
Centex Industrial Park;  
Myer - off dead wye;  
Touny Ave MP 10.0;  
Com. Ed - MP 12.3;

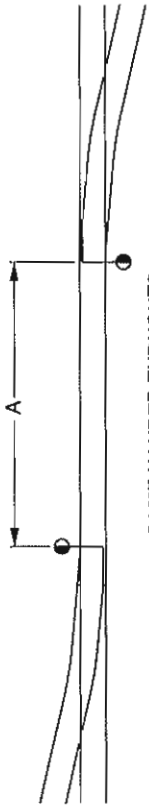

**SAME HANDED TURNOUTS**  
PREFERRED ARRANGEMENT

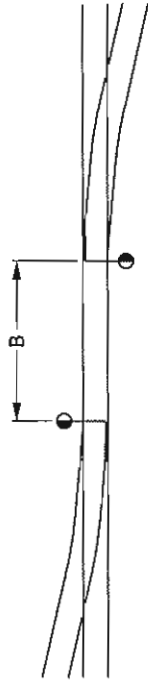

**SAME HANDED TURNOUTS**  
MINIMUM ARRANGEMENT

SAME HANDED TURNOUTS		
TURNOUT	A	B
9	100'	60'
11	100'	60'
15	125'	90'
20	160'	120'
24	160'	120'

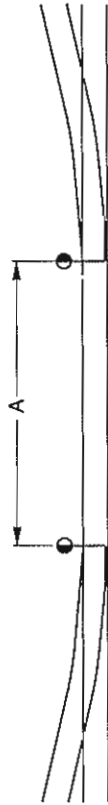

**OPPOSITE HANDED TURNOUTS**  
PREFERRED ARRANGEMENT

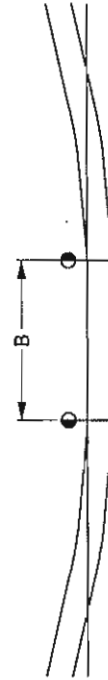

**OPPOSITE HANDED TURNOUTS**  
MINIMUM ARRANGEMENT

OPPOSITE HANDED TURNOUTS		
TURNOUT	A	B
9	100'	60'
11	100'	60'
15	125'	90'
20	160'	120'
24	160'	120'

**NOTES:**

- INSULATED JOINTS MAY BE REQUIRED AT CERTAIN LOCATIONS. SIGNAL SPACING AND CIRCUITS WILL GOVERN.
- FOR RAIL JOINT LOCATIONS THROUGH THE TURNOUT AREAS, SEE UPRR STD DWGS 5000 THRU 5999 AND COMMON STD DWGS 341000 THRU 347999.
- WHERE IT APPEARS THAT GROUND CONDITIONS REQUIRE A DEVIATION FROM THE ARRANGEMENTS SHOWN, APPROVAL WILL BE CONSIDERED UPON WRITTEN REQUEST TO THE CHIEF ENGINEER, SETTING FORTH SUCH SIGNIFICANT REASONS.

**UNION PACIFIC RAILROAD  
ENGINEERING STANDARDS**

**FACING POINT TURNOUT  
ARRANGEMENT**



ADOPTED: NOV. 17, 1972  
REVISED: FEB. 20, 2007  
FILE NO.: 0017A

STD DWG  
0017A

STD DWG  
0017A

## SUPERELEVATION RUNOFF RATES

ALL SUPERELEVATION SHALL BE RUNOFF THROUGHOUT THE LENGTH OF THE SPIRAL ON THE CURVE SO THE TRACK IS LEVEL AT THE POINT OF TANGENT. WHERE CONDITIONS MAKE IT ABSOLUTELY NECESSARY TO RUNOFF A PORTION OF THE SUPERELEVATION ON TANGENT TRACK, IT SHALL BE DONE AT THE SAME RATE OF RUNOFF AS USED ON THE SPIRAL OF THE CURVE.

COLUMN 2 IS BASED UPON A RATE OF CHANGE OF SUPERELEVATION OF 1.25" PER SECOND OF TIME, EXCEPT THE MAXIMUM RATE OF CHANGE SHALL NOT EXCEED THE RATE OF 3/4" PER 33'-0" OF DISTANCE. SUPERELEVATION RUNOFF RATES SHOWN IN THIS COLUMN ARE RECOMMENDED RATES AND SHOULD BE USED UNLESS LOCAL CONDITIONS PREVENT.

COLUMN 3 IS BASED UPON A RATE OF CHANGE OF SUPERELEVATION OF 1.50" PER SECOND OF TIME, EXCEPT THE MAXIMUM RATE OF CHANGE SHALL NOT EXCEED THE 3/4" PER 33'-0" OF DISTANCE. RATES SHOWN IN THIS COLUMN ARE MINIMUM RATES AND SHALL BE USED WHERE LOCAL CONDITIONS RESTRICT SUPERELEVATION RUNOFFS. THIS MAY OCCUR WHERE CURVES ARE LOCATED IN CLOSE PROXIMITY TO BRIDGES, TURNOUTS, OR OTHER CURVES.

MAXIMUM SPEED FOR CURVES IN MPH	PREFERRED DISTANCE REQUIRED FOR EACH INCH CHANGE IN THE SUPERELEVATION	MINIMUM DISTANCE REQUIRED FOR EACH INCH CHANGE IN THE SUPERELEVATION
COLUMN 1	COLUMN 2	COLUMN 3
20	44	44
25	44	44
30	44	44
35	44	44
40	47	44
45	53	44
50	59	49
55	65	54
60	70	59
65	76	64
70	82	69
75	88	73
80	94	78
85	100	83
90	106	88

## SUPERELEVATION DESIGN CRITERIA

THE TABLES ON STANDARD DRAWINGS 0020, 0021, 0022, 0023 INDICATE DESIGN SUPERELEVATIONS FOR VARIOUS IMBALANCE CONDITIONS. THE SUPERELEVATIONS INCLUDED IN THESE DRAWINGS ARE FOR DESIGN PURPOSES AND ARE NOT MAINTENANCE STANDARDS. ACTUAL IN-TRACK SUPERELEVATIONS MAY VARY FROM THE APPROVED DESIGN ELEVATIONS WITHIN PARAMETERS OUTLINED IN THE M/W RULES AND FRA TRACK SAFETY STANDARDS WITHOUT ANY ADVERSE EFFECTS ON THE SAFETY OF TRAIN OPERATIONS. THE FOLLOWING DESIGN STANDARDS SHOULD BE USED IN SELECTING WHICH IMBALANCE CONDITION TO USE IN VARIOUS APPLICATIONS.

### FOR FREIGHT TRAIN OPERATIONS

USE STD DWG 0021 (1" IMBALANCE) TO DETERMINE DESIGN SUPERELEVATION PROVIDED INDICATED SUPERELEVATION IS 4" OR LESS. IF THE 1" IMBALANCE TABLE INDICATES A REQUIRED SUPERELEVATION OF OVER 4", STD DWG 0022 (2" IMBALANCE) SHOULD BE USED TO DETERMINE APPROPRIATE SUPERELEVATION.

### FOR PASSENGER TRAIN OPERATIONS

USE STD DWG 0023 (3" IMBALANCE) TO DETERMINE DESIGN SUPERELEVATION.

DESIGN SUPERELEVATION SHOULD NEVER EXCEED (5) INCHES.

ALL NEW DESIGN SUPERELEVATIONS WILL BE APPROVED BY THE CHIEF ENGINEER AS OUTLINED IN MW RULE 48.1.2. THE CHIEF ENGINEER MAY APPROVE EXCEPTIONS TO THIS STANDARD CONSISTENT WITH TYPICAL OPERATING PRACTICES (E.G. EQUILIBRIUM SUPERELEVATIONS WHERE MOST ALL TRAINS OPERATE AT MAXIMUM SPEED OR 2" IMBALANCE ELEVATIONS WHERE TRAINS RARELY OPERATE AT MAXIMUM SPEED). STD DWG 0023 (3" IMBALANCE) INDICATES THE MINIMUM ELEVATION/MAXIMUM SPEED ALLOWED BY THE FRA TRACK SAFETY STANDARDS AND MUST NOT BE VIOLATED.

NEW DESIGN SUPERELEVATIONS WILL BE APPROVED AND INSTALLED IN EXISTING MAIN LINE TRACKS IN CONJUNCTION WITH ANNUAL TRACK PROGRAMS WHICH INVOLVE SURFACING AND LINING.

UNION PACIFIC RAILROAD  
ENGINEERING STANDARDS

SUPERELEVATION OF CURVES  
GENERAL



ADOPTED: MARCH 1, 1998  
REVISED: SEPT. 7, 1998  
FILE NO.: 0019A

STD DWG  
0019A

STD DWG  
0019A

		SPEED IN MILES PER HOUR																	
DECIMAL DEGREE OF CURVE	DEGREE OF CURVE IN DEGREE/ MINS/SECS	10	15	20	25	30	35	40	45	50	55	60	65	70	75	80	85	90	
0.5°	0°-30'																		
1.0°	1°-00'								1/2"			1/4"	1/2"	3/4"	1"	1 1/4"	1 1/2"	1 3/4"	
1.5°	1°-30'						1/4"	3/4"	1 1/4"	1 3/4"	2 1/4"	2 3/4"	3 1/2"	4 1/4"	5"				
2.0°	2°-00'					1/4"	3/4"	1 1/4"	1 3/4"	2 1/2"	3 1/4"	4 1/4"	5"						
2.5°	2°-30'					1/2"	1 1/4"	1 3/4"	2 1/2"	3 1/4"	4 1/4"								
3.0°	3°-00'				1/4"	1"	1 1/2"	2 1/4"	3 1/4"	4 1/4"									
3.5°	3°-30'				1/2"	1 1/4"	2"	3"	4"										
4.0°	4°-00'				3/4"	1 1/2"	2 1/2"	3 1/2"	4 3/4"										
4.5°	4°-30'			1/4"	1"	1 3/4"	2 3/4"	4"											
5.0°	5°-00'			1/2"	1 1/4"	2 1/4"	3 1/4"	4 1/2"											
5.5°	5°-30'			1/2"	1 1/2"	2 1/2"	3 3/4"												
6.0°	6°-00'			3/4"	1 3/4"	2 3/4"	4 1/4"												
6.5°	6°-30'			3/4"	1 3/4"	3"	4 1/2"												
7.0°	7°-00'			1"	2"	3 1/2"	5"												
7.5°	7°-30'		1/4"	1"	2 1/4"	3 3/4"													
8.0°	8°-00'		1/4"	1 1/4"	2 1/2"	4"													
9.0°	9°-00'		1/2"	1 1/2"	3"	4 1/4"													
10.0°	10°-00'		1/2"	1 3/4"	3 1/2"														
11.0°	11°-00'		3/4"	2"	3 3/4"														
12.0°	12°-00'		1"	2 1/4"	4 1/4"														

NOTES:  
 THESE REQUIREMENTS DO NOT REPRESENT MAINTENANCE STANDARDS; THEREFORE, DO NOT USE THEM TO DETERMINE APPROVED ELEVATION WHEN SURFACING AND LINING EXISTING CURVES. FOR EXISTING CURVES, USE CURVE DATA INFORMATION IN THE CURVE DATA HANDBOOK OR IN THE ON-LINE INTRANET ENGINEERING PLANNING AND BUDGETING SITE.  
<http://home.uprr.com/depts/engineering/apps/eims/curves/curvesreporting.cfm>  
 NO SUPERELEVATION (E) GREATER THAN 5" SHALL BE INSTALLED.  
 REFERENCE STD DWG 0019.

E = ELEVATION OF THE OUTSIDE RAIL IN INCHES  
 D = DEGREE OF CURVE IN DECIMAL DEGREE FORMAT  
 S = SPEED IN MILES PER HOUR

CONVERSIONS ARE AS FOLLOWS:

$$E = S(0.0007SD) - 1"$$

R = RADIUS OF CURVE IN FEET

$$D = \frac{5729.578}{R}$$

$$S(\text{max.}) = \sqrt{\frac{E + 1}{(0.0007)D}}$$

UNION PACIFIC RAILROAD  
 ENGINEERING STANDARDS

# SUPERELEVATION OF CURVES 1" IMBALANCE



ADOPTED: DEC. 31, 1998  
 REVISED: JUNE 23, 2003  
 FILE NO.: 0021C

STD DWG  
 0021C

STD DWG  
 0021C

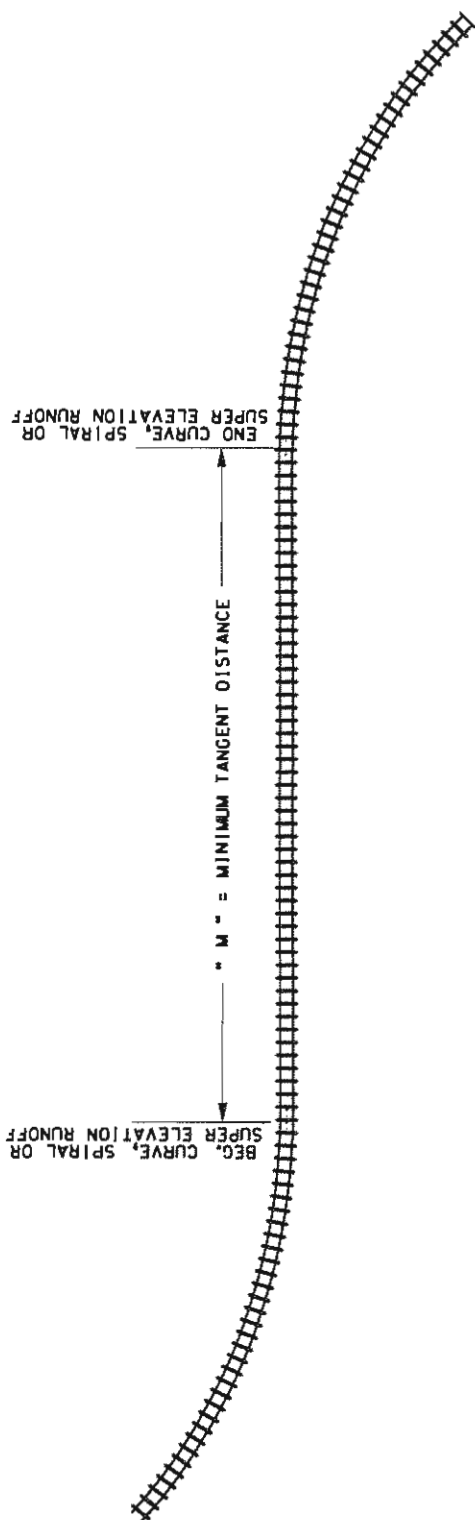

MAIN LINE AND BRANCH LINES

TRACK SPEED / TYPE	"M" DISTANCE
60 MPH AND ABOVE	500 FEET
40 MPH THRU 59 MPH	300 FEET
39 MPH AND BELOW	150 FEET

YARD AND INDUSTRY TRACKS

DEGREE OF CURVE	MINIMUM TANGENT DISTANCE "M"
7° 30' OR LESS	36 FEET
GREATER THAN 7° 30'	60 FEET

NOTES:  
 ADJACENT SIDINGS AND RUNNING TRACKS SHALL CONFORM TO THE CRITERIA OF THE MAIN TRACK, REGARDLESS OF THE ALLOWABLE SPEED ON THE SIDING OR RUNNING TRACK.

CONNECTIONS TO ADJACENT TRACKS SHALL BE DESIGNED AND CONSTRUCTED AS SHOWN ON STANDARD LAYOUT PLANS FOR MAINLINE TURNOUTS AND CROSSOVERS.

FOR MAIN AND BRANCH TRACKS, THE POINT OF SWITCH OR POINT OF FROG OF ANY TURNOUT SHALL BE NO CLOSER THAN 200 FEET FROM THE END OF A HORIZONTAL CURVE OR SUPERELEVATION RUNOFF, UNLESS AUTHORIZED BY THE CHIEF ENGINEER.

UNION PACIFIC RAILROAD  
 ENGINEERING STANDARDS

MINIMUM TANGENT  
 DISTANCE



ADOPTED: DEC. 31, 1996  
 REVISED:  
 FILE NO.: 0018

STD DWG  
 0018

STD DWG  
 0018

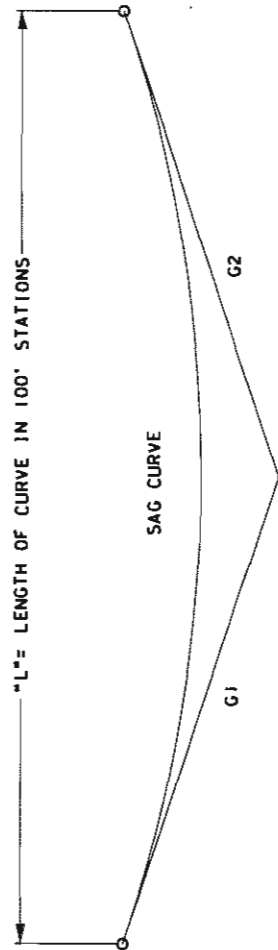

SUMMIT CURVE

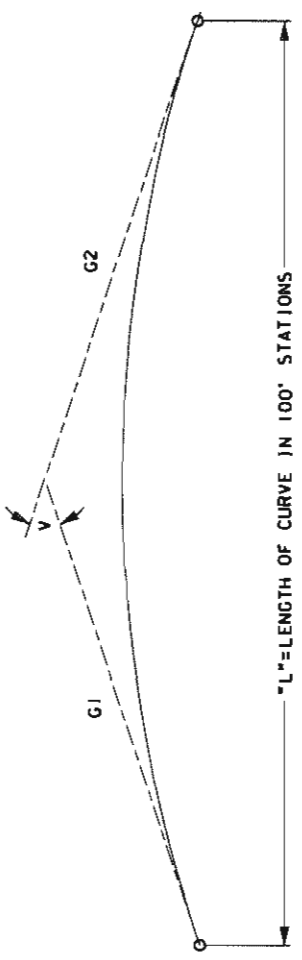

$$V/L = \frac{|G2 - G1|}{L}$$

G1 AND G2 DESIGNATE GRADES IN PERCENT.  
 L=LENGTH OF CURVE IN 100' STATIONS.  
 V=ALGEBRAIC DIFFERENCE IN GRADES IN PERCENT(G2-G1)  
 V/L=AVERAGE CHANGE IN GRADIENT PER 100' STATION.  
 TO DETERMINE LENGTH (L), DIVIDE V BY THE DESIRED V/L  
 ROUND UP THE RESULT TO THE NEAREST 100' STATION.

EXAMPLES:  
 GIVEN G1= 1.05 AND G2=-0.71  $V=(1.05 - (-0.71)) = 1.76\%$   
 GIVEN  $V/L = 0.10$   $L = \frac{1.76}{0.10} = 17.6'$  STATION.  
 VERTICAL CURVE LENGTH= 1800' (ROUNDED UP).

NOTES:  
 VERTICAL CURVES SHALL NOT FALL WITHIN THE  
 LIMITS OF HORIZONTAL CURVES OR TURNOUTS  
 UNLESS AUTHORIZED BY THE CHIEF ENGINEER.

UNION PACIFIC RAILROAD  
 ENGINEERING STANDARDS

VERTICAL CURVE  
 DESIGN



ADOPTED: DEC. 31, 1996  
 REVISED:  
 FILE NO.: 0016

STD DWG  
 0016

TRACK	MAXIMUM V/L	
	SAG	SUMMIT
ALL MAIN TRACKS	0.06	0.10
BRANCH TRACK SPEEDS 40 MPH AND GREATER	0.06	0.10
BRANCH TRACK SPEEDS UNDER 40 MPH	0.12	0.20
YARD TRACKS	0.40	0.80
INDUSTRIAL LEAOS	0.60	1.00
INDUSTRY TRACK	1.20	2.00

STD DWG  
 0016





APPENDIX D

PHOTOGRAPHS



# ALGONQUIN ROAD GRADE SEPARATION LOCATION



ALGONQUIN LOOKING EAST



ALGONQUIN LOOKING WEST



UPRR LOOKING NORTH



UPRR LOOKING SOUTH

# UPRR SIGNAL EQUIPMENT



AT-GRADE CROSSING



SIG BOX LOOKING SOUTH



SIG BOX LOOKING NORTH



SIG BOX LOOKING SOUTH

# INDUSTRY LEAD SOUTH OF ALGONQUIN ROAD



POINT OF SWITCH (PS)



POWER



FROG LOOKING SOUTH



PS LOOKING NORTH

# UPRR WAYSIDE SIGNAL



SIGNALS LOOKING NORTH



CLOSE UP



PARK ON WEST SIDE OF TRACKS



HOME ON WEST SIDE OF TRACKS

# INDUSTRY LEAD NORTH OF ALGONQUIN ROAD



LEAD LOOKING NORTH



LEAD LOOKING NORTH



POINT OF FROG



LEAD/UPRR LOOKING SOUTH

# DEMPSTER STREET



LOOKING NORTH



SPUR/UPRR LOOKING NORTH



DEMPSTER LOOKING EAST



DEMPSTER LOOKING WEST



# OAKTON STREET



LOOKING EAST



LOOKING SOUTH



LOOKING NORTH

# MISCELLANEOUS VEHICLES



UNITED PASSENGER BUS



SCHOOL BUS



TRAFFIC LOOKING WEST



TRAFFIC LOOKING EAST

# HONEYWELL/UOP DRIVE 30 E. ALGONQUIN ROAD



LOOKING EAST



LOOKING WEST TOWARDS DRIVE



DRIVE LOCATION



DRIVE

# HONEYWELL/UOP DRIVE 50 E. ALGONQUIN ROAD



2<sup>ND</sup> DRIVE FROM UPRR



LOOKING EAST



DRIVE LOCATION



DRIVE LOOKING WEST

# HONEYWELL/UOP DRIVE 25 & 95 E. ALGONQUIN ROAD



95 E. LOOKING SOUTH



95 E. LOOKING SOUTH



25 E. LOOKING SOUTH

# ITW FASTEX

## 195 E. ALGONQUIN ROAD



FASTEX



LOOKING SOUTH TO FASTEX



LOOKING SOUTH FROM FASTEX POND



LOOKING SOUTHWEST FROM FASTEX POND

# ITW FASTEX NWI WETLAND



WETLAND LOOKING SOUTH



WETLAND LOOKING EAST



CONTROL STRUCTURE LOOKING SOUTH



WETLAND LOOKING NORTH

# HONEYWELL/UOP DRIVE 200 E. ALGONQUIN ROAD



UOP DRIVE LOCATION



UOP LOOKING SOUTH



UOP LOOKING NORTH



UOP LOOKING EAST



# JUNO LIGHTING

## 1300 S. WOLF ROAD



DRIVE LOOKING EAST



DRIVE LOOKING EAST



DRIVE LOOKING EAST



LOOKING SOUTH @ PK LOT

# JUNO LIGHTING NWI WETLAND



WETLAND LOOKING EAST



WETLAND LOOKING SOUTHEAST



WETLAND LOOKING WEST



WETLAND LOOKING NORTHWEST

# DES PLAINES PARK DISTRICT

## 510 E. ALGONQUIN ROAD



LOOKING WEST



LOOKING SOUTHEAST



LOOKING SOUTH



LOOKING SOUTHEAST

# DES PLAINES PARK DISTRICT ENTRANCE



LOOKING NORTHWEST



LOOKING NORTHEAST



CULVERT WEST



CULVERT EAST

# DES PLAINES PARK DISTRICT ADJACENT TO UPRR



BATTING CAGES



SKATE PARK



SKATE PARK



MINI GOLF

# DES PLAINES PARK DISTRICT BIKE PATH



BIKE PATH LOOKING WEST



BIKE PATH LOOKING NORTHWEST



LOOKING NORTH



BIKE PATH LOOKING NORTH

# DES PLAINES PARK DISTRICT POND/MINI GOLF



LOOKING SOUTHWEST



LOOKING WEST



LOOKING NORTHWEST



LOOKING NORTH

# SHOPPING CENTER

## 526-537 ALGONQUIN ROAD



SIGN LOOKING WEST



LOOKING NORTHWEST



EAST DRIVE LOOKING SOUTHWEST



EAST AND WEST DRIVE LOOKING SOUTHWEST



# STAR AUTOMOTIVE 540 ALGONQUIN ROAD



LOOKING WEST



LOOKING NORTHWEST



LOOKING SOUTH

# SHOPPING CENTER 554-590 ALGONQUIN ROAD



LOOKING WEST



LOOKING EAST



LOOKING NORTHEAST



LOOKING NORTHEAST

# AC DELCO

## 1190 S. WOLF ROAD



LOOKING NORTH



LOOKING NORTHWEST



LOOKING EAST



LOOKING NORTH



APPENDIX E

DESIGN VISUALIZATIONS





1051 Perimeter Drive, Suite 1025  
Schaumburg, Illinois 60173  
(847) 605-9600 | (847) 605-9610 Fax  
www.transystems.com

**ALGONQUIN ROAD OVERPASS  
BIRD'S EYE LOOKING SOUTH**

EXHIBIT NO.  
**DV-1**  
ALTERNATIVE 1



1051 Perimeter Drive, Suite 1025  
Schaumburg, Illinois 60173  
(847) 605-9600 | (847) 605-9610 Fax  
www.transystems.com

**ALGONQUIN ROAD UNDERPASS  
BIRD'S EYE VIEW LOOKING SOUTH**

EXHIBIT NO.  
**DV-1**  
ALTERNATIVE 2





**ALGONQUIN ROAD OVERPASS  
AT MOUNTAIN VIEW ADVENTURE CENTER LOOKING SOUTH**



1051 Perimeter Drive, Suite 1025  
Schaumburg, Illinois 60173  
(847) 605-9600 | (847) 605-9610 Fax  
www.transystems.com

**ALGONQUIN ROAD UNDERPASS  
AT MOUNTAIN VIEW ADVENTURE CENTER LOOKING SOUTH**

EXHIBIT NO.  
**DV-2**  
ALTERNATIVE 2



1051 Perimeter Drive, Suite 1025  
Schaumburg, Illinois 60173  
(847) 605-9600 | (847) 605-9610 Fax  
www.transystems.com

**ALGONQUIN ROAD OVERPASS  
AT ALGONQUIN ROAD LOOKING WEST**



EXHIBIT NO.  
**DV-3**  
ALTERNATIVE 1

1051 Perimeter Drive, Suite 1025  
Schaumburg, Illinois 60173  
(847) 605-9600 | (847) 605-9610 Fax  
www.transystems.com



**ALGONQUIN ROAD UNDERPASS  
AT ALGONQUIN ROAD LOOKING WEST**



EXHIBIT NO.  
**DV-3**  
ALTERNATIVE 2

1051 Perimeter Drive, Suite 1025  
Schaumburg, Illinois 60173  
(847) 605-9600 | (847) 605-9610 Fax  
www.transystems.com



**ALGONQUIN ROAD OVERPASS  
AT ALGONQUIN ROAD LOOKING WEST**



EXHIBIT NO.  
**DV-4**  
ALTERNATIVE 1

1051 Perimeter Drive, Suite 1025  
Schaumburg, Illinois 60173  
(847) 605-9600 | (847) 605-9610 Fax  
www.transystems.com



# ALGONQUIN ROAD UNDERPASS AT ALGONQUIN ROAD LOOKING WEST



EXHIBIT NO.  
**DV-4**  
ALTERNATIVE 2



1051 Perimeter Drive, Suite 1025  
Schaumburg, Illinois 60173  
(847) 605-9600 | (847) 605-9610 Fax  
www.transystems.com

# ALGONQUIN ROAD OVERPASS AT UPRR LOOKING SOUTH



EXHIBIT NO.  
**DV-5**  
ALTERNATIVE 1



1051 Perimeter Drive, Suite 1025  
Schaumburg, Illinois 60173  
(847) 605-9600 | (847) 605-9610 Fax  
www.transystems.com

# ALGONQUIN ROAD OVERPASS AT UPRR LOOKING SOUTH



EXHIBIT NO.

**DV-5**

ALTERNATIVE 1





1051 Perimeter Drive, Suite 1025  
Schaumburg, Illinois 60173  
(847) 605-9600 | (847) 605-9610 Fax  
www.transystems.com

**ALGONQUIN ROAD OVERPASS  
AT ALGONQUIN ROAD LOOKING EAST**



EXHIBIT NO.

**DV-6**

ALTERNATIVE 1



1051 Perimeter Drive, Suite 1025  
Schaumburg, Illinois 60173  
(847) 605-9600 | (847) 605-9610 Fax  
www.transystems.com

**ALGONQUIN ROAD UNDERPASS  
AT ALGONQUIN ROAD LOOKING EAST**



EXHIBIT NO.  
**DV-7**  
ALTERNATIVE 2